

# WELKEN

We Provide the World with High Quality  
Products and Perfect Service

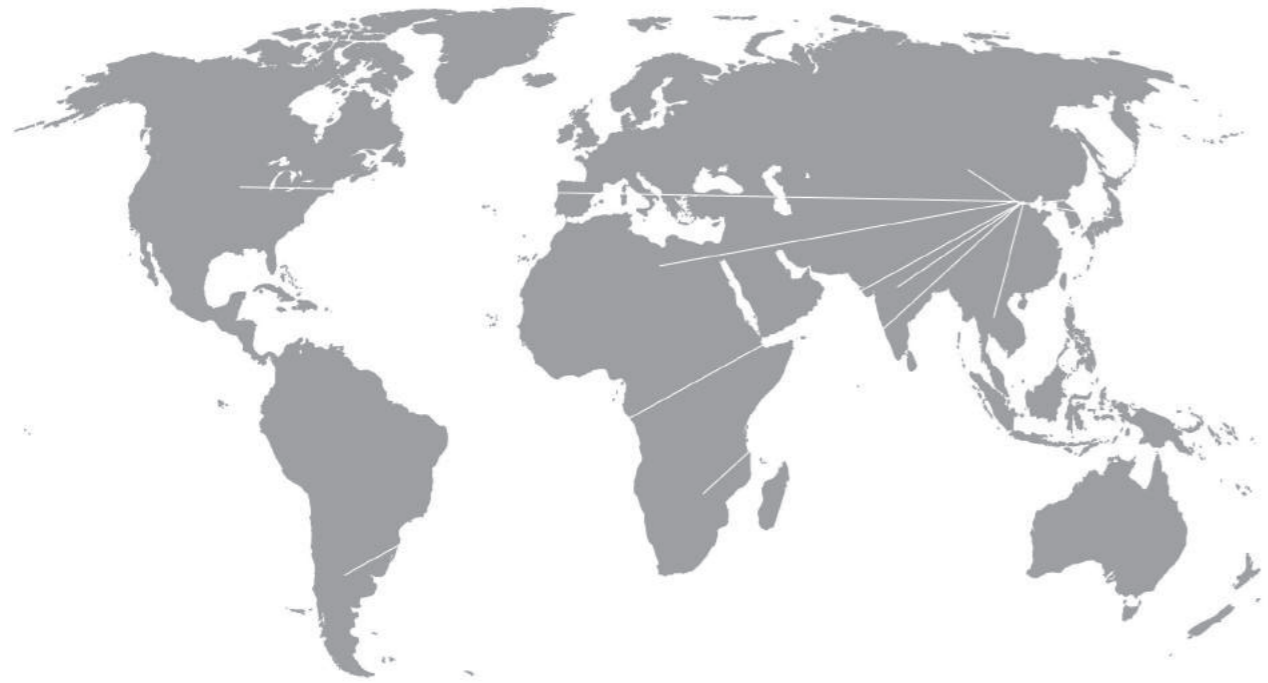

## WELKEN

Marst Safety Equipment (Tianjin) Co., Ltd

Tel: +86-22-88823317

Fax: +86-22-58712985

E-Mail: [welken@chinawelken.com](mailto:welken@chinawelken.com)

[marst@chinawelken.com](mailto:marst@chinawelken.com)

Web: [www.chinawelken.com](http://www.chinawelken.com)

[www.chinamarst.com](http://www.chinamarst.com)

# WELKEN



**Make You In Safe**  
**Top Picks For Safety**   
LOOK INSIDE

Marst Safety Equipment (Tianjin) Co., Ltd



Marst Safety Equipment (Tianjin) Co., Ltd is the professional manufacturer who focus on research and development, production and sales of personal protective equipment. Our company holds the concept of "With quality to win credibility, science and technology to win the future" and always focus on brand building and products innovation. We own independent intellectual property rights and professional R&D team, dedicated to provide customers with quality services and one-stop solutions for personal safety protection.

Our factory was built in 1998. In 2007, in order to promote the products to the international market, Tianjin Bradi Security Equipment Co., Ltd, which has import and export right was established. We highly pay attention to customer's value and are committed to continuous products and services improvement.

We are also the Chinese supplier of Made-in-China and Alibaba. For more than ten years, we have actively promoted exchanges and cooperation with customers from all over the world through global professional exhibitions held in Germany, the United States and other areas. Our products are exported to more than 50 countries and regions. We have nearly 100 invention patents and utility models. The main products of safety lockout, eye wash stations, safety tripods, have passed CE certificates, and eye wash stations also have ANSI certificates. We strive to create world-class levels products and provide work safety and security for more customers! In 2016, Tianjin Bradi Security Equipment Co., Ltd was recognized as a national high-tech enterprise. In 2019, in order to achieve leap-forward development, the company integrated its business into Marst Safety Equipment (Tianjin) Co., Ltd formed a scientific and technological manufacturing enterprise, which mainly integrates R&D, production, sales and technical services. It consists of five business segments: safety lockout, eye wash stations, safety tripods, intelligent shoe making machine and food machine.

God helps those who help themselves; great virtue can carry all things. Marst Safety Equipment (Tianjin) Co., Ltd has always been committed to continuous improvement and surpassing development, and is committed to providing more quality safety products to domestic and foreign customers.

## ANSI certificate CE certificate



## Patent certificate



Safety Padlock 04



PVC Tags and Warning Sign 10



Electrical Lockout 11



Valve Lockout 22



Hasp Lockout 28



Cable Lockout 31



Lockout Station 35



Other Types of Safety Lockout 40



## What is Lockout/Tagout ?

In a locked way to avoid people operating isolated power sources or equipment casually until the isolation finished and the Lockout/ Tagout removed. By using Lockout Tags to warn people the isolated power sources or equipment cannot be operated casually.

## Why use Lockout/Tagout ?

1. Prevent accident, protect life;
2. Improve production efficiency;
3. Save cost.

## Please use the Lockout/Tagout to lock the following power sources:

1. Power;
2. Hydraulic energy;
3. Pneumatic energy;
4. Gravity;
5. Chemical energy;
6. Heat;
7. Radiant energy.

## Relevant laws and regulations:

- Law of the People's Republic of China on Work Safety (November 2002)
- Occupation Health and Safety Management Systems (December 2001)
- Working Regulation of Power Safety (January 1987)
- Safety Production License Regulations (March 2006)
- Safety and Hygiene Regulations for Plant (May 1956)
- Occupation Disease Prevention and Control Law (May 2002)
- Occupation Health Supervision and Management Approach (May 2002)
- National Mine Safety Law (November 1992)
- Control of Hazardous Energy (Lockout/Tagout)(American OSHA,29CFR 1910.147)
- Europe in Work Safety and Health Regulations (European OSHA)
- National Standard for Plant [NOHSC:1010](Australian )

## Lockout/Tagout Procedures:

1. Prepare for shutdown.  
Identify the type of energy (power, machinery...) and potential hazards, locate the isolation devices and prepare to turn off the energy source.
2. Notification  
Inform the relevant operators and supervisors who may be affected by isolating the machine.
3. Shut down  
Shut down the machine or equipment.
4. Isolate the machine or equipment  
Under necessary conditions, set isolation area for the machine or equipment which need Lockout/Tagout, such as warning tape, safety fence to isolate.
5. Lockout/Tagout  
Apply Lockout/Tagout for hazardous power source.
6. Release hazardous energy  
Release stocked hazardous energy, such as stocked gas, liquid. (Note: This step can operate before step 5, as per the actual situation to confirm.)
7. Verify  
After Lockout/Tagout, verify the isolation of the machine or equipment is valid.

## Remove Lockout/Tagout Procedures:

1. Check tools, remove isolation facilities;
2. Check staff;
3. Remove Lockout/Tagout devices;
4. Inform relevant staff;
5. Restart equipment energy.

## The Function and Ways of Using the Key

### Keyed to Differ

Each padlock has unique key, padlock cannot open mutually.

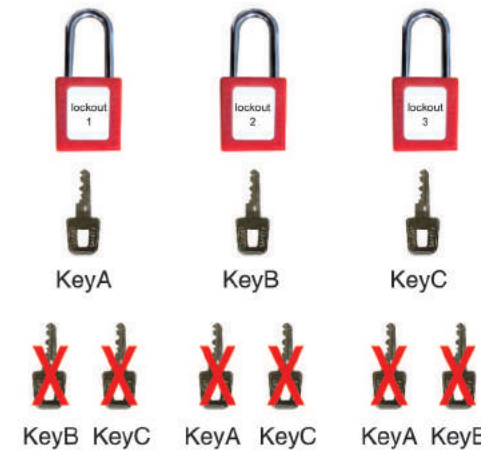

### Keyed Alike

Within a group, all padlocks can open mutually, one key or several keys can open all padlocks in this group. Can customize several groups, between groups cannot open mutually.



### Master&Differ

Within a group, each padlock just has unique key, padlock cannot open mutually, but one master key can open all padlocks in the group. Can customize several groups, different master keys between groups cannot open mutually.

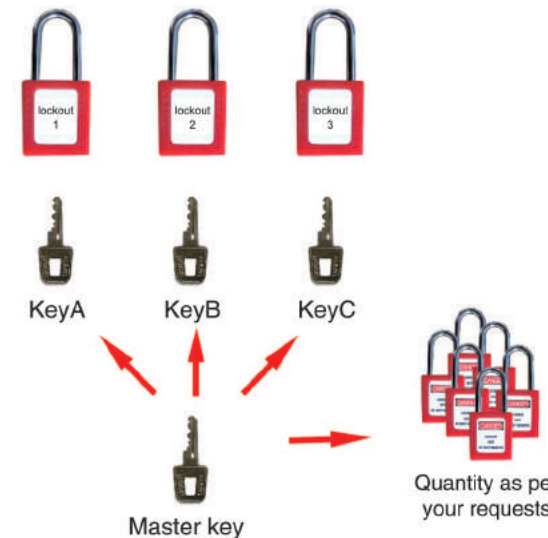

### Master&Alike

Within a group, all padlocks can open mutually, one key or several keys can open all padlocks in this group. Can customize several groups, between groups cannot open mutually. And if need open all groups padlocks, can add a master key.

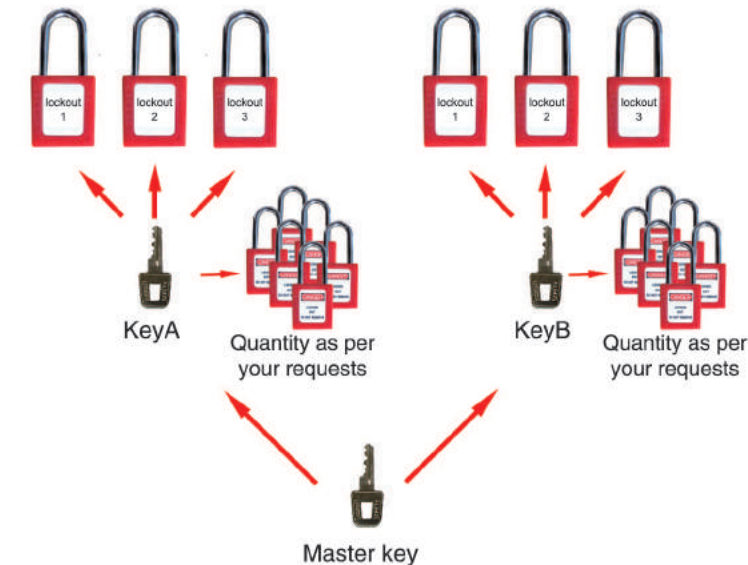



## Padlock Function

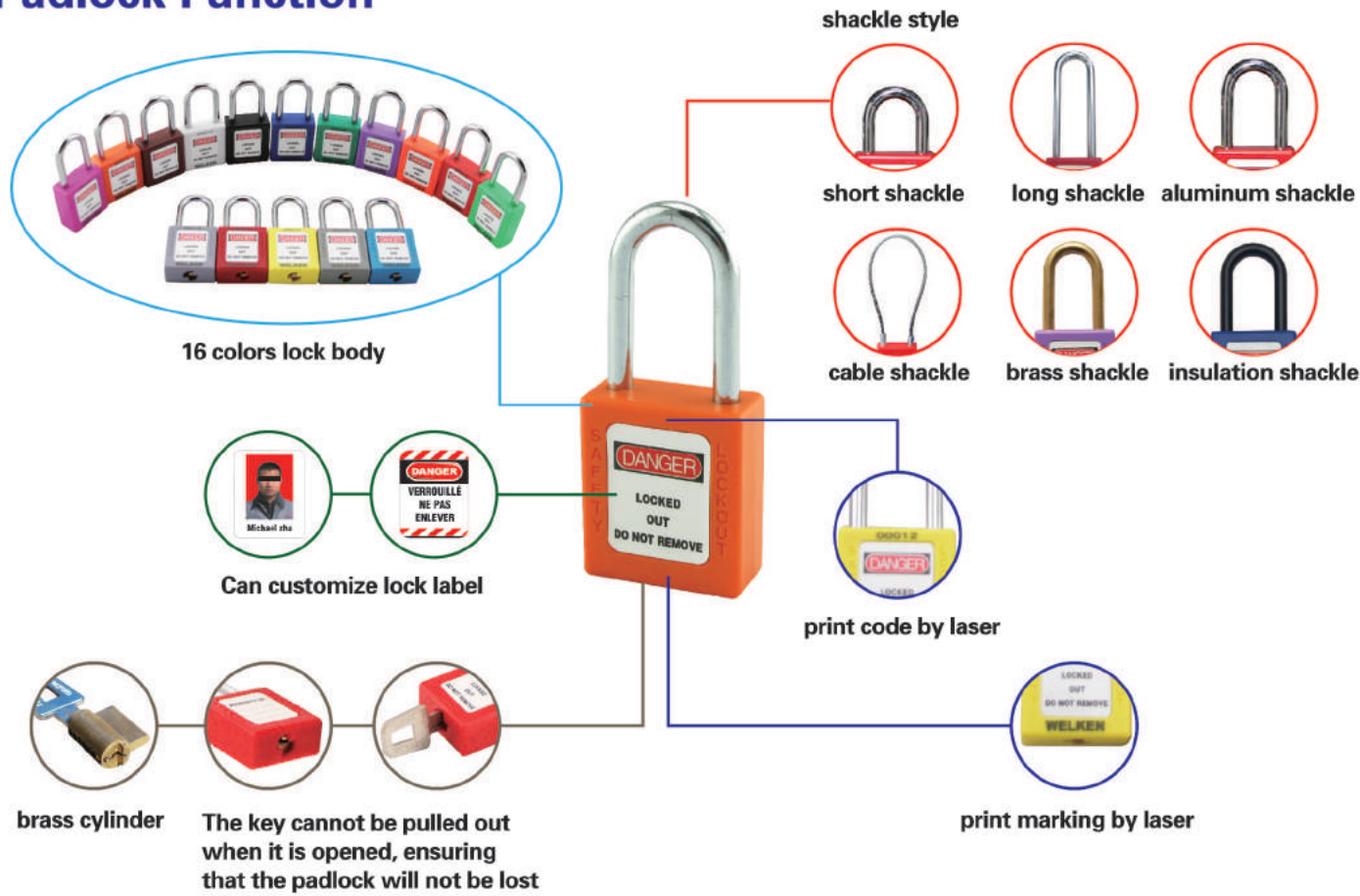

## The Function and Ways of the Colors of the Key

The company can provide key shells of 16 different colors to collocate keys, making the functions of keys more powerful.

- For example, the supervisor's key covers black shell and the personal key without shell, so that when it is used, it can easily distinguish which is the supervisor key.
- Different departments use different colors key. For example, the electrical maintenance department uses a key with a red shell with a red padlock, the locksmith department uses a key with a yellow shell with a yellow padlock, and the production department uses a key with a blue shell with a blue padlock. In this way, the color can distinguish which department is overhauling or which department's key, which facilitates the key management. The company can backup and archive the customer's padlock key according to the customer's request, so that the customer's key management system will be supplemented in the future which also can avoid the confusion of the original key management system.

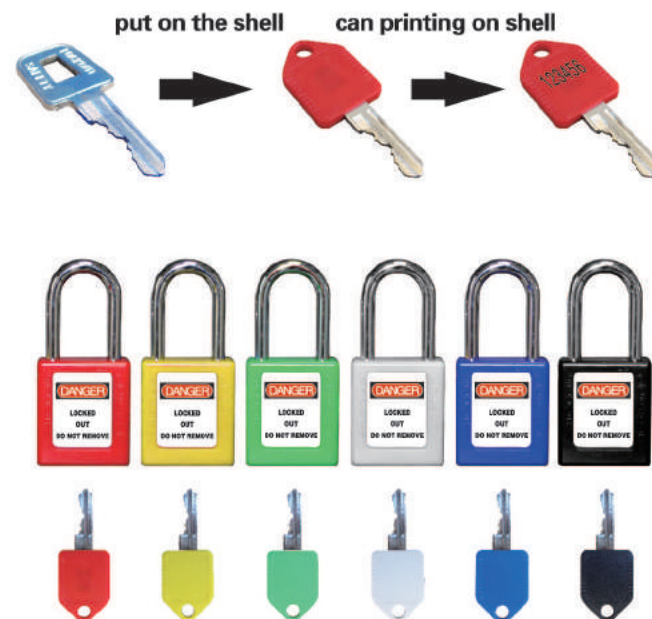

## Safety Padlock

- ABS lock body is resistant impact, UV, corrosion, high and low temperature, shackle is heavy steel chrome plated, hard and beautiful.
- Lock body dimensions: Length 45mm, Width 40mm, Thickness 19mm; Shackle Diameter 6mm, Shackle Height 25mm, 38mm, 76mm three types to choose.
- Include 2 sets lock body warning labels, can write owner's information.
- 16 colors ABS lock body, convenient to choose.

Model	Description	Shackle Height
BD-8511	Keyed to differ, key-retaining	25mm
BD-8512	Keyed alike, key-retaining	
BD-8513	Master&alike, key-retaining	
BD-8514	Master&differ, key-retaining	38mm
BD-8521	Keyed to differ, key-retaining	
BD-8522	Keyed alike, key-retaining	
BD-8523	Master&alike, key-retaining	76mm
BD-8524	Master&differ, key-retaining	
BD-8525	Keyed to differ, key-retaining	
BD-8526	Keyed alike, key-retaining	
BD-8527	Master&alike, key-retaining	
BD-8528	Master&differ, key-retaining	





- Meticulous workmanship, SUS304 material, beautiful, resistance corrosion and antirust
- Double leakage hole to prevent water accumulation, corrosion
- Arc edge design, grinding, good handle without cutting hands
- Thicker SUS304 shackle can prevent cutting, sawing; safety and reliability
- There are four specifications lock body to choose; each specification can collocate long shackle or short shackle.

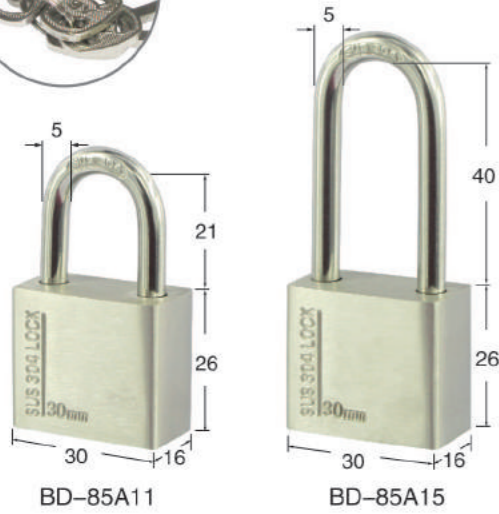
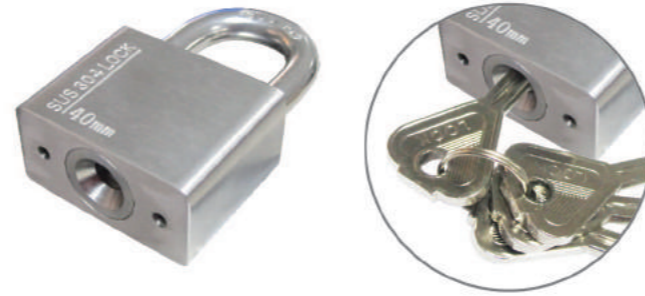

Model	Description	Size of Lock Body	Height of Shackle
BD-85A11	Keyed to differ, key-retaining	Width:30mm Height: 26mm Thickness: 16mm	Clear height:21cm Diameter: 5mm Distance: 15mm
BD-85A12	Keyed alike, key-retaining		
BD-85A15	Keyed to differ, key-retaining		Clear height: 40cm Diameter: 5mm Distance: 15mm
BD-85A16	Keyed alike, key-retaining		

Model	Description	Size of Lock Body	Height of Shackle
BD-85A21	Keyed to differ, key-retaining	Width:40mm Height: 32mm Thickness: 20mm	Clear height:26cm Diameter: 7.2mm Distance: 20mm
BD-85A22	Keyed alike, key-retaining		
BD-85A25	Keyed to differ, key-retaining		Clear height: 46cm Diameter: 7.2mm Distance: 20mm
BD-85A26	Keyed alike, key-retaining		

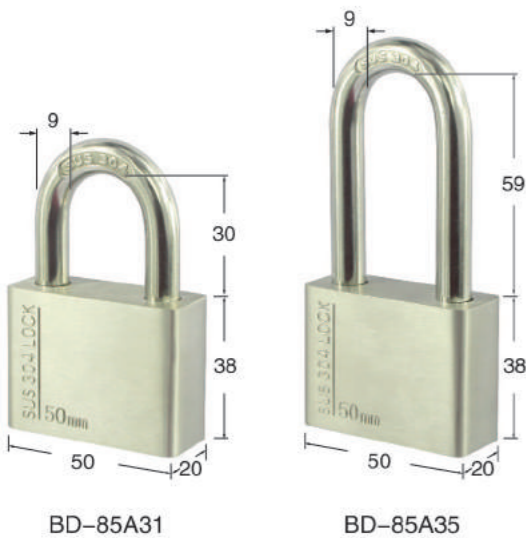
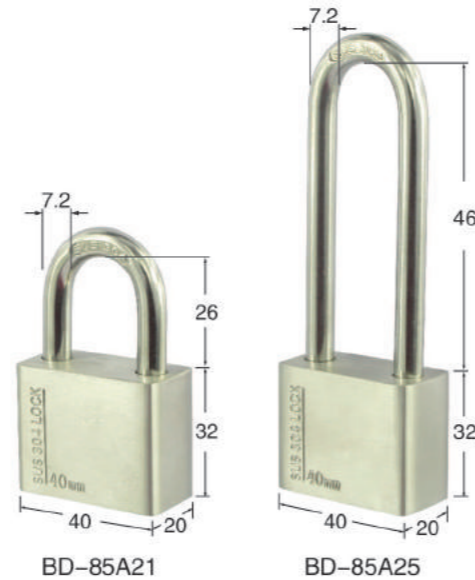

Model	Description	Size of Lock Body	Height of Shackle
BD-85A31	Keyed to differ, key-retaining	Width:50mm Height: 38mm Thickness: 20mm	Clear height:30cm Diameter: 9mm Distance: 23mm
BD-85A32	Keyed alike, key-retaining		
BD-85A35	Keyed to differ, key-retaining		Clear height: 59cm Diameter: 9mm Distance: 23mm
BD-85A36	Keyed alike, key-retaining		

Model	Description	Size of Lock Body	Height of Shackle
BD-85A41	Keyed to differ, key-retaining	Width:60mm Height: 42mm Thickness: 20mm	Clear height:36cm Diameter: 11mm Distance: 28mm
BD-85A42	Keyed alike, key-retaining		
BD-85A45	Keyed to differ, key-retaining		Clear height: 59cm Diameter: 11mm Distance: 28mm
BD-85A46	Keyed alike, key-retaining		

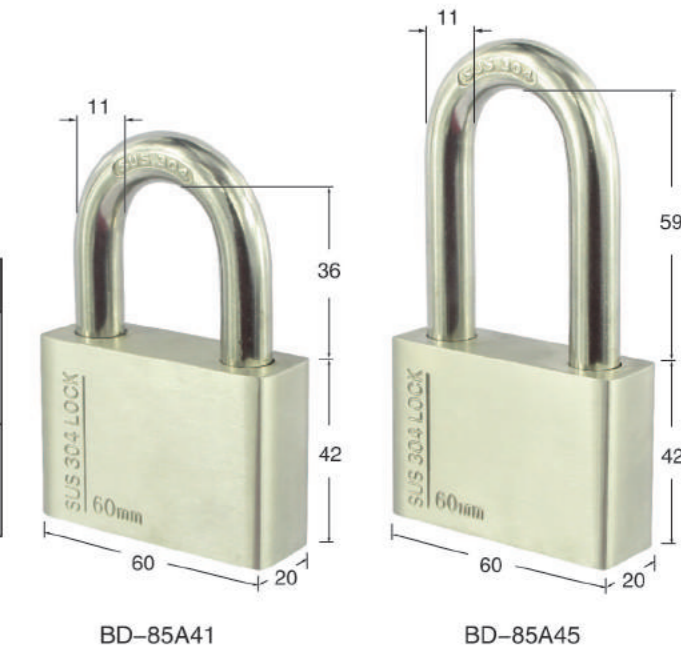

## Aluminum Padlock



- Suitable for chemical, automobile industry etc., light and solid, resistant chemical corrosion, high and low temperature, UV, and impact.
- Aluminum lock body, Chromium plated steel shackle, light and solid, bear a strong external force.
- Brass cylinder is more resistant corrosion, 6 cartridge cylinder improve the anti-lock by others.
- Provided eight colourful mental which include red, yellow, green, blue, black, purple, white, and orange
- Arc lock body design, height:40mm, width: 39mm, thickness: 19mm. Chromium plate steel shackle, height: 44mm and 78mm to choose, diameter: 6.35mm.
- Differ cylinder lockout, each lock can provide two keys, it also customize by the user.

Model	Description	Shackle Height
BD-85B11	Keyed to differ, key-retaining	44mm
BD-85B12	Keyed alike, key-retaining	
BD-85B13	Master & alike, key-retaining	
BD-85B14	Master & differ, key-retaining	
BD-85B15	Keyed to differ, key-retaining	78mm
BD-85B16	Keyed alike, key-retaining	
BD-85B17	Master & alike, key-retaining	
BD-85B18	Master & differ, key-retaining	

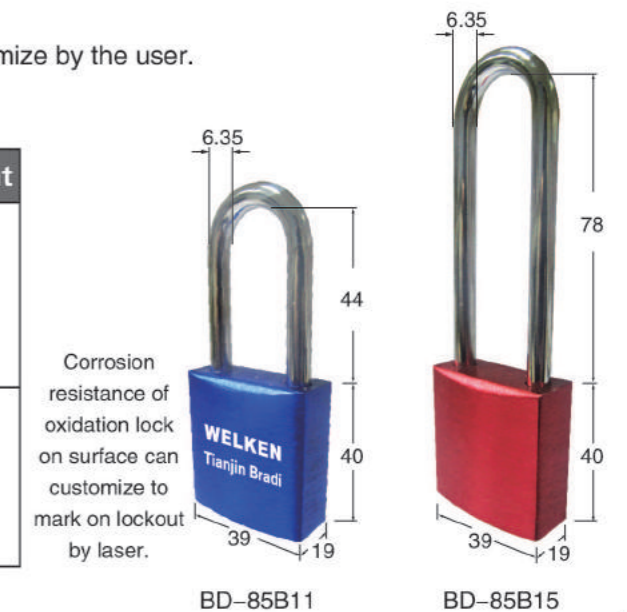



## Insulation Safety Padlock

- ABS lock body and nylon shackle combined perfectly, with better non-conductive, anti-magnetism, explosion-proof quality.
- Nylon shackle is non-conductive, especially suitable for chemical industry, military, mining, power and flammable and explosive areas.
- Lock body dimensions: Length 45mm, Width 40mm, Thickness 19mm; Shackle Diameter 6mm, Shackle Height 38mm.
- All fittings of padlock are explosion-proof, anti-magnetism, insulation, corrosion-resistant.
- Include 2 sets lock body warning labels, can write owner's information.
- 16 colors ABS lock body, convenient to choose.

Model	Description	Shackle Material
BD-8531	Keyed to differ, key-retaining	Nylon
BD-8532	Keyed alike, key-retaining	
BD-8533	Master&alike, key-retaining	
BD-8534	Master&differ, key-retaining	



## Spark-proof Aluminum Safety Padlock

- ABS lock body is resistant impact, UV, corrosion, high and low temperature.
- Spark-proof aluminum shackle, anti-static, anti-magnetism, explosion-proof, corrosion-resistant.
- Lock body dimensions: Length 45mm, Width 40mm, Thickness 19mm; Shackle Diameter 6mm, Shackle Height 38mm.
- Include 2 sets lock body warning labels, can write owner's information.
- 16 colors ABS lock body, convenient to choose.



Model	Description	Shackle Material
BD-8541	Keyed to differ, key-retaining	Spark-proof aluminum
BD-8542	Keyed alike, key-retaining	
BD-8543	Master&alike, key-retaining	
BD-8544	Master&differ, key-retaining	

## Brass Shackle Safety Padlock

- ABS lock body is resistant impact, UV, corrosion, high and low temperature.
- Brass shackle, anti-static, anti-magnetism, explosion-proof, corrosion-resistant.
- Lock body dimensions: Length 45mm, Width 40mm, Thickness 19mm; Shackle Diameter 6mm, Shackle Height 38mm.
- Include 2 sets lock body warning labels, can write owner's information.
- 16 colors ABS lock body, convenient to choose.

Model	Description	Shackle Material
BD-8551	Keyed to differ, key-retaining	Brass
BD-8552	Keyed alike, key-retaining	
BD-8553	Master&alike, key-retaining	
BD-8554	Master&differ, key-retaining	



## Laminated Steel Safety Padlock

- WELKEN laminated padlock is suitable for using special environment.
- Can stick obvious warning labels on lock body, easy to identify and manage.
- Lock body is made of high resistance steel layer, shackle is high resistance steel with plating layer, hard and durable.
- Lock body dimensions: Length 36.2mm, Width 40mm, Thickness 23.5mm.
- The board on lock body for label, 8 colors to choose, easy to identify.

Model	Description	Shackle Height
BD-8561	Keyed to differ, key-retaining	27mm
BD-8562	Keyed alike, key-retaining	
BD-8565	Keyed to differ, key-retaining	46mm
BD-8566	Keyed alike, key-retaining	

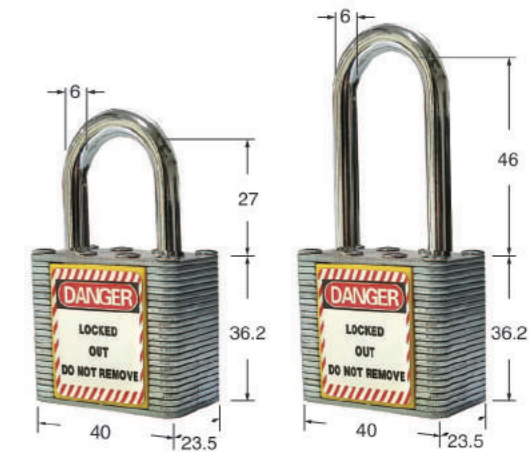

BD-8561

BD-8565

## Long Lock Body Safety Padlock

- ABS lock body is resistant impact, UV, corrosion, high and low temperature.
- Lock body dimensions: Length 80mm, Width 40mm, Thickness 19mm.
- Shackle is high resistance steel with plating layer, hard and beautiful.
- Include 2 sets lock body warning labels, can write owner's information.
- 16 colors ABS lock body, convenient to choose.

Model	Description	Shackle Height
BD-8571	Keyed to differ, key-retaining	38mm
BD-8572	Keyed alike, key-retaining	
BD-8573	Master&alike, key-retaining	
BD-8574	Master&differ, key-retaining	76mm
BD-8575	Keyed to differ, key-retaining	
BD-8576	Keyed alike, key-retaining	
BD-8577	Master&alike, key-retaining	
BD-8578	Master&differ, key-retaining	



BD-8571

BD-8575



### ABS Stainless Steel Shackle Safety Padlock

- ABS lock body is resistant impact, UV, corrosion, high and low temperature.
- Lock body dimensions: Length 45mm, Width 36.5mm, Thickness 16.5mm, shackle diameter 5mm.
- Shackle is made of 316 stainless steel, anti-acid, anti-alkali, anti-corrosion of many types of chemicals.
- Include 2 sets lock body warning labels, can write owner's information.

Model	Description	Shackle Height
BD-8581	Keyed to differ, key-retaining	38mm
BD-8582	Keyed alike, key-retaining	



### ABS Dust-proof Safety Padlock

- ABS lock body is resistant impact, UV, corrosion, high and low temperature.
- Lock body dimensions: Length 45mm, Width 40mm, Thickness 19mm, shackle diameter 6 mm.
- The sealer to block keyhole is PP, soft and durable, good sealing.
- Include 2 sets lock body warning labels, can write owner's information.

Model	Description	Shackle Height
BD-8591	Keyed to differ, key-retaining	38mm
BD-8592	Keyed alike, key-retaining	
BD-8593	Master&alike, key-retaining	
BD-8594	Master&differ, key-retaining	



### PVC Tags

- PVC material, sunscreen ink printing, suitable for outdoor.
- 10 pieces per bag.
- Can customize as per customers' requests.

#### Regular Type



BD-8611 PVC Tags Length:145mm Width: 75mm Thickness:0.8mm Keyhole diameter: 8mm

#### Customize Type



### Safety Signs

BD-8621 PVC Warning Signs Material: PVC Printing requests: dimensions and content can customize as per requests.  
 BD-8622 Sticky Warning Signs Material: Sticky Printing requests: dimensions and content can customize as per requests.





## Miniature Circuit Breaker Lockout

- Be made of ABS resin, nylon, corrosion resistance and good insulation performance.
- Pin out, with a unique design of the rod, easy to install.
- Use with professional safety padlock and tag together.



BD-8111      BD-8112      BD-8114

Model	Description
BD-8111	Pin out, suitable for the circuit breaker toggle switch width ≤ 12mm, ABS
BD-8112	Pin out, suitable for the circuit breaker toggle switch width ≤ 20mm, ABS
BD-8114	Pin in, suitable for locking space maximum 12.7mm, ABS materials

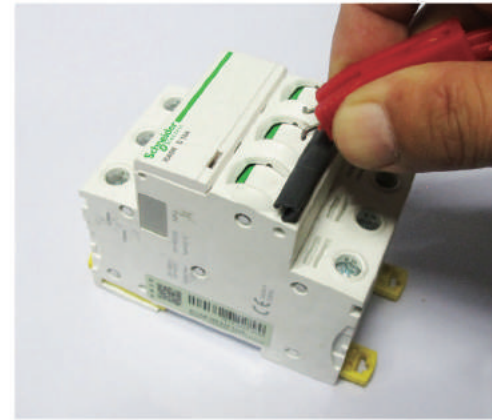

## Multi-mini Breaker Lockout

- Be made of ABS resin, corrosion resistance and good insulation performance.
- External dimensions: Length 58mm, Width 42mm, Thickness 14.5mm.
- With a handle can tighten directly to install, easy to use, without assistant tools.
- Use with professional safety padlock and tag together, padlock can be horizontal or vertical locked in two methods.

Model	Description
BD-8113	Suitable for the circuit breaker toggle switch thickness maximum 9mm, no limit for width.



Step 1

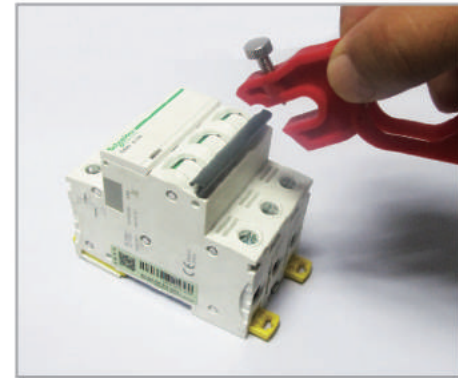

Step 2

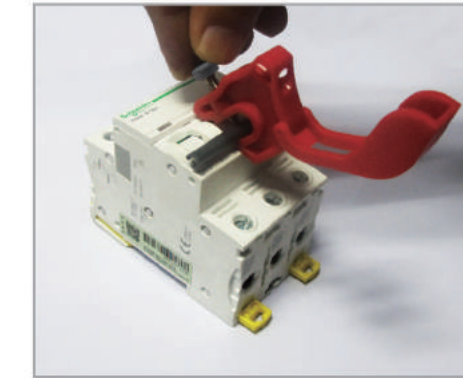

Step 3

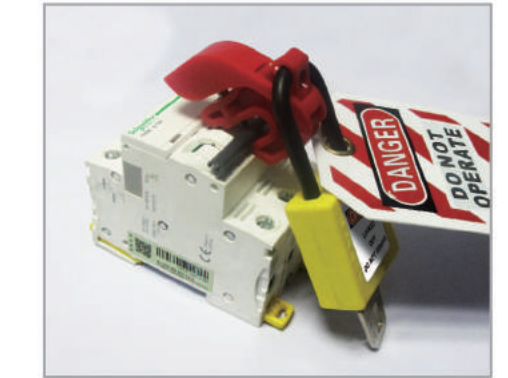

**NEW!**

## Push Button Miniature Circuit Breaker Lockout

- Be made of ABS and brass screw with chrome plated.
- With a screw can tighten to install, easy to use, without assistant tools.
- Special square hole card slot and screw can guarantee will not appear any swing after be locked.
- Can customize to mark on lockout by laser.

Model	Description
BD-8118	Suitable for push button circuit breaker (button dimensions ≤ 14.5mm X 22mm)

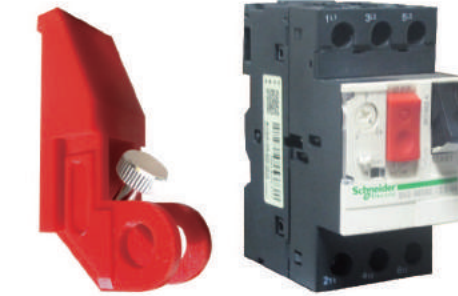

suitable this kind of circuit breaker

Step 1

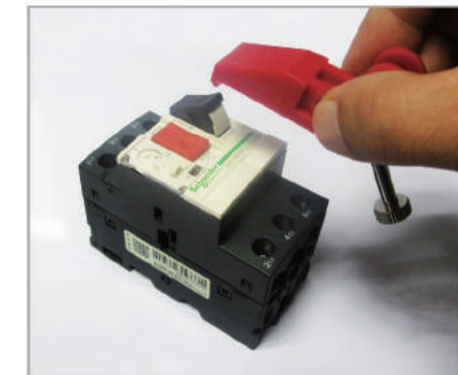

Step 2

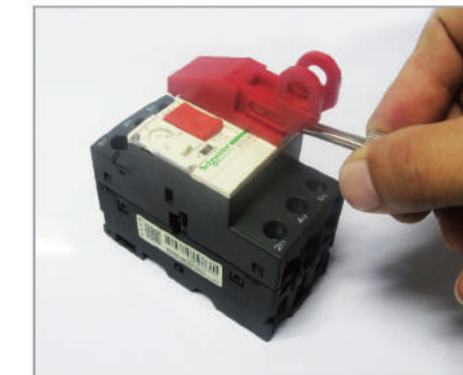

Step 3





## Multi-function Circuit Breaker Lockout

- Be made of ABS and brass screw with chrome plated.
- With a screw can tighten to install, easy to use, without assistant tools.
- Special square hole card slot and screw can guarantee will not appear any swing after be locked.
- Can customize to mark on lockout by laser.

Model	Description
BD-8119	Suitable for miniature circuit breaker (handle width ≤ 17mm, handle thickness ≤ 15mm)

Step 1

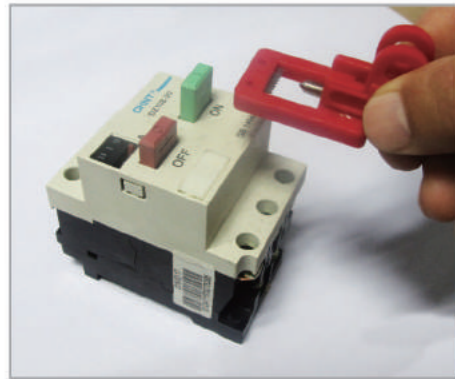

Step 2

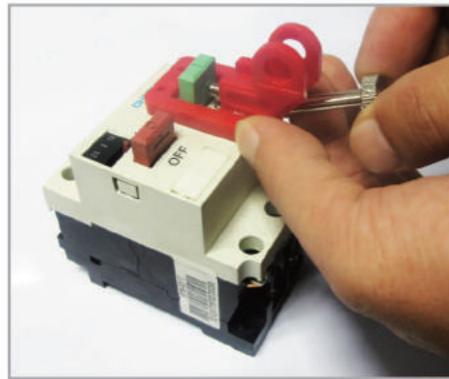

Step 3

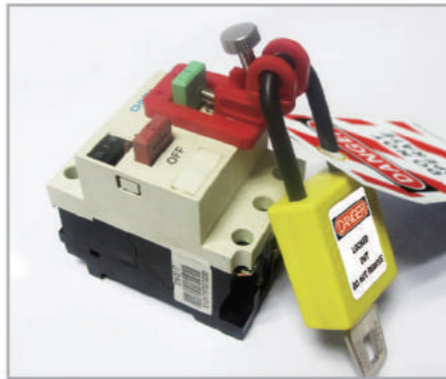

**NEW!**



suitable this kind of circuit breaker

## Circuit Breaker Lockout(small)

- Be made of ABS resin, corrosion resistance and good insulation performance.
- Special stainless steel teeth design, fixed by screw, providing better bite for handle.
- According to the circuit breaker handle space, the adjustable baffle can move to confirm the suitable position.
- Use with professional safety padlock and tag together.



Model	Description
BD-8121	Suitable for handle width < 19.5mm, thickness < 10mm

Step 1



Step 2



Step 3



## Moulded Case Circuit Breaker Lockout

- Made from rugged reinforced nylon PA.
- Can lock it with screw driver.
- Can accommodate one safety padlock with shackle diameter ≤7mm.
- Can lock all kinds of circuit breakers.



BD-8123A



BD-8123B



BD-8123C



BD-8123D



BD-8123E



BD-8123F

Model	Description
BD-8123A	Suitable for single pole miniature circuit breakers with handle width ≤ 7.7mm.
BD-8123B	Suitable for 2 to 4 poles miniature circuit breaker
BD-8123C	Suitable for mini and middle size circuit breakers with handle width ≤ 5mm
BD-8123D	Suitable for mini and middle size circuit breakers with handle width ≤ 5mm
BD-8123E	Suitable for large size circuit breakers
BD-8123F	Suitable for mini size circuit breakers with handle width ≤ 9.3mm, middle size circuit breakers with handle width ≤ 12mm

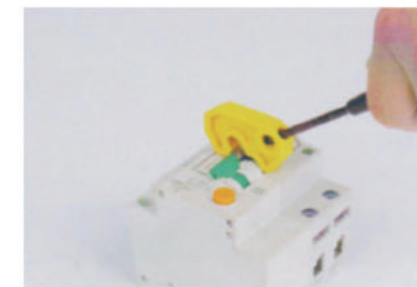

BD-8123A



BD-8123B

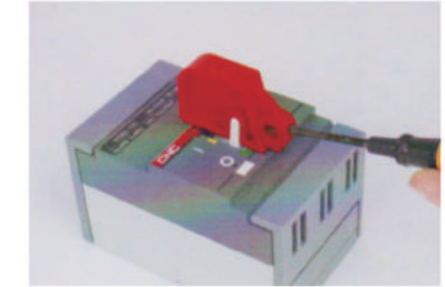

BD-8123C



BD-8123E



BD-8123F



BD-8123F



### Circuit Breaker Lockout(big)

- Be made of ABS resin, corrosion resistance and good insulation performance.
- Special stainless steel teeth design, fixed by screw, providing better bite for handle.
- Use with professional safety padlock and tag together.

Model	Description
BD-8122	Suitable for handle width < 41mm, thickness < 15.8mm



### Circuit Breaker Lockout(big)

- Shell is made of ABS resin, and main body is zinc alloy.
- With a knob can tighten directly to install, easy to use, without assistant tools.
- Use with professional safety padlock and tag together.

Model	Description
BD-8127	Suitable for the circuit breaker toggle switch width < 60mm, thickness < 23mm.



### Knife-switch Lockout

- Be made of ABS resin, corrosion resistance and good insulation performance.
- One set includes a red and a green, and red indicates connection, green indicates disconnection.
- Use with professional safety padlock and tag together.



Model	Description
BD-8125	Suitable for 220/380V circuit breaker

Step 1



Step 2

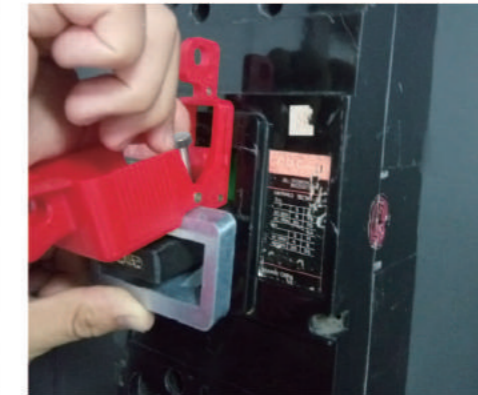

Step 3



### Circuit Breaker Lockout(small)

- Shell is made of ABS resin, and main body is zinc alloy.
- External dimensions: Length 68.5mm, Width 23.5mm, Thickness 14mm.
- With a knob can tighten directly to install, easy to use, without assistant tools.
- Use with professional safety padlock and tag together.

Model	Description
BD-8126	Suitable for the circuit breaker toggle switch thickness < 10mm, no limit for width.

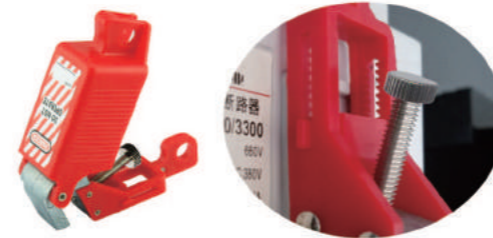

### Multi-function Medium-sized Circuit Breaker Lockout

- Be made of ABS and brass screw with chrome plated.
  - With a screw can tighten to install, easy to use, without assistant tools.
- The unique T slot design makes lockout more solid and reliable

Model	Description
BD-8128	Suitable for all kinds of medium-sized circuit breaker (handle thickness: 11mm-18mm, no limit to width).



Step 1



Step 2



Step 3



Step 1



Step 2



Step 3





## 480V~600V Breaker Lockout

- Made from engineering plastic alloy.
- Back self-adhesive track can fix on the distributor forever—clean the surface of the distributor no hole needed.
- To lock the special large or unique shape switch, the length of the rod is 19cm.
- Red stop rod means the switch is in the off state, green stop rod means the switch is in on state

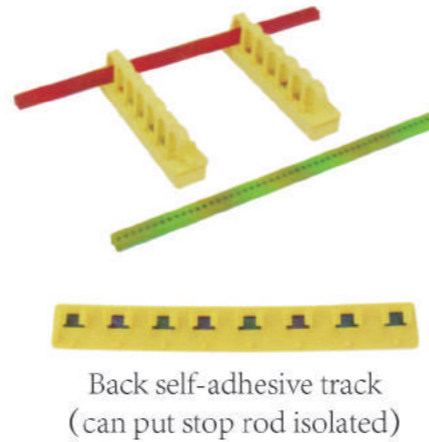

Model	Description
BD-8129	Can accommodate two safety padlocks with shackle diameters≤7mm

## Emergency Stop Lockout



- It is transparent acrylic injection molding, with warning yellow base, safe and eye-catching.
- Install on the push-pulled or knob released emergency stop button to prevent misoperation permanently.
- Use with professional safety padlock and tag together.

Model	Description
BD-8131	Install hole diameter 22mm
BD-8132	Install hole diameter 30.5mm

## Electric Button Switch Lockout

- It is transparent ABS resin injection molding.
- Bottom border use double-sided adhesive tape to stick, easy to install.
- Use with professional safety padlock and tag together.



Model	Description
BD-8141	Bottom hole diameter 29mm

## Universal Switch Lockout



- Be made of impact resistant transparent ABS resin.
- Bottom border use double-sided adhesive tape to stick, easy to install.
- Use with professional safety padlock and tag together.

Model	Description
BD-8142	Bottom square hole size 69mm X 69mm, applicable for most square switches.

## Quick Install Emergency Stop Lockout

- It is transparent acrylic injection molding.
- The lockout is made up of two parts: the lockout cover and the base. The base is fixed on the bottom of the switch. Just need to install or remove the lockout cover and easy to use.
- Use with professional safety padlock and tag together.



BD-8136



8133 Install Base



8134 Install Base



8135 Install Base



Model	Description
BD-8136	Diameter 62mm, height 54mm

## Quick Install Gear Switch Lockout

- It is transparent acrylic injection molding.
- The lockout is made up of two parts: the lockout cover and the base. The base is fixed on the bottom of the switch. Just need to install or remove the lockout cover and easy to use.
- Use with professional safety padlock and tag together.



BD-8145



8143 Install Base



8144 Install Base



Model	Description
BD-8145	Diameter 71.5mm, height 99mm

Step 1



Step 2



Step 3





## Electric Switch Lockout

- It is transparent ABS resin injection molding.
- External dimensions: Length 61.7mm, Width 30.5mm, Height 18.5mm;
- Bottom border use double-sided adhesive tape to stick, easy to install.
- Use with professional safety padlock and tag together.



Model	Description
BD-8151	Bottom hole size: Length 32mm, Width 27mm

## General Wall Switch Lockout

- It is industrial grade transparent ABS resin injection molding, beautiful and practical and can lock switch effectively. Prevent accidental operation.
- Applicable 110V ~ 220V Chinese standard 86 series wall switch.
- Lockout open method: up and down to open.
- Use with professional safety padlock and tag together.



Model	Description
BD-8161	External dimensions: Length 124mm, Width 96.5mm, Thickness 33.5mm

## General Wall Socket Lockout

- It is industrial grade transparent ABS resin injection molding, beautiful and practical and can lock socket effectively. Prevent accidental operation.
- Lockout open method: left and right to open.
- Use with professional safety padlock and tag together.



Model	Description
BD-8162	Applicable 110V ~ 220V Chinese standard 86 series wall socket

## General Wall Switch Lockout (European and American Standards)

- It is industrial grade high strength polypropylene injection molding, beautiful and practical and can lock switch effectively. Prevent accidental operation.
- Lockout open method: up and down to open.
- Use with professional safety padlock and tag together.



Model	Description
BD-8171	Applicable 110V ~ 220V European and American Standards wall switch

## Plug Lockout

- Be made of ABS resin, side hole diameter 10mm.
- Stick with sunscreen label can write the name of the person in charge and matters.
- Use with professional safety padlock and tag together.



Model	Description
BD-8181	External dimensions: Length 103mm, Width 60mm, Height 60mm

## Big Plug Lockout

- Be made of ABS resin, side hole diameter 25mm.
- Four lock holes are available, multiple persons co-management to prevent accidental connection.
- Use with professional safety padlock and tag together.



Model	Description
BD-8182	External dimensions: Length 178mm, Width 80mm, Thickness 85mm

## Two-phase Plug Lockout

- Be made of ABS resin, patent protection product.
- Stick with sunscreen label can write the name of the person in charge and matters.
- Use with professional safety padlock and tag together.



Model	Description
BD-8183	Applicable 220V two-phase flat plug

## Three-phase Plug Lockout

- Be made of ABS resin, patent protection product.
- Stick with sunscreen label can write the name of the person in charge and matters.
- Use with professional safety padlock and tag together.



Model	Description
BD-8184	Applicable 10A 220V three-phase power plug
BD-8185	Applicable 16A 220V three-phase power plug



## European Standard Two-phase Plug Lockout

- Be made of ABS resin, patent protection product.
- Stick with sunscreen label can write the name of the person in charge and matters.
- Use with professional safety padlock and tag together.

Model	Description
BD-8186	Applicable 220V two-phase round plug and European standard power plug



## Trapezoidal Plug Lockout

- Be made of ABS resin, trapezoidal plug lockout, patent protection product.
- Use with professional safety padlock and tag together.



Model	Description
BD-8187	Provide lock protection for the computer host and electrical equipment

## Crane Lift Controller Lockout Bag

- Made of sewing tear-resistant nylon fabric, length 450mm, width 250mm.
- There is a PVC barrier in the bag to prevent people from accidentally starting the controller button.
- The bag surface is marked with warning sign.
- Use with professional safety padlock and tag together.



BD-8191



BD-8192



Model	Description
BD-8191	External dimensions: Length 450mm, Width 250mm
BD-8192	External dimensions: Length 450mm, Width 250mm

## Ball Valve Lockout

- Be made of high strength polypropylene, excellent anti-fracture, wear resistance and insulation performance.
- Can adjust the position of the padlock arbitrarily, convenient and quick.
- Use with professional safety padlock and tag together.

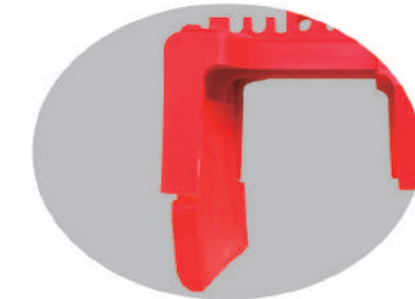

Model	Description
BD-8211	External dimensions: Length 208mm, Width 77mm, Height 130mm

## Rotation Valve Lockout

- Be made of reinforced nylon PA6 and stainless steel, durable and resistance to chemicals, corrosion resistance.
- Unique design to lock the ball valve from which handle can be removed.
- Use with professional safety padlock and tag together.



Model	Description
BD-8214	Suitable for handle up to 34mm X 49mm

Step 1: orthogonal



Step 2: screw tightly



Step 3: lock





## Single Arm Universal Ball Valve Lockout

- Be made of reinforced nylon PA6 and stainless steel, with better impact resistance and excellent chemical resistance.
- Advanced trapezoidal upper teeth improves the bite strength of valve handle.
- The rotating arm makes the bite more tight and improves the safety performance.
- Two gear adjustable
- Use with professional safety padlock and tag together.

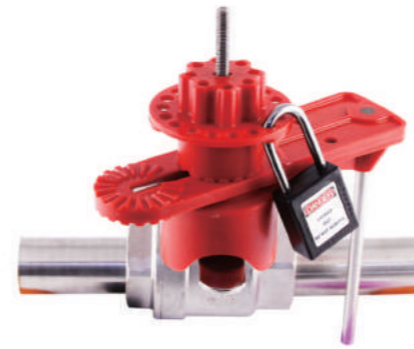

Model	Description
BD-8212	External dimensions: Length 205mm, Width 50mm, Height 275mm Suitable for handle width 19mm-46mm, suitable for handle maximum thickness 25mm, rotating arm length 170mm

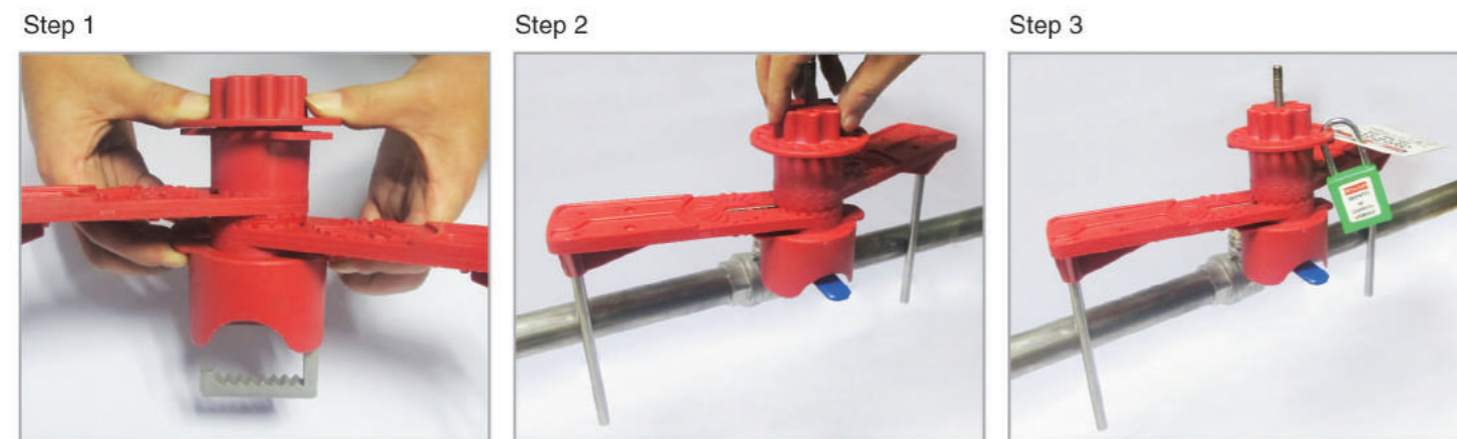
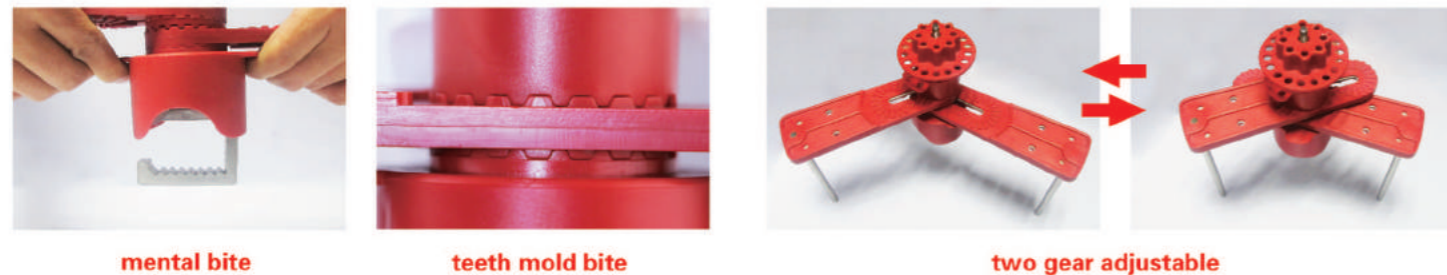

## Double Arms Universal Ball Valve Lockout

- Be made of reinforced nylon PA6 and stainless steel, with better impact resistance and excellent chemical resistance.
- Advanced trapezoidal upper teeth improves the bite strength of valve handle.
- The rotating arm makes the bite more tight and improves the safety performance.
- Two gear adjustable
- Use with professional safety padlock and tag together.

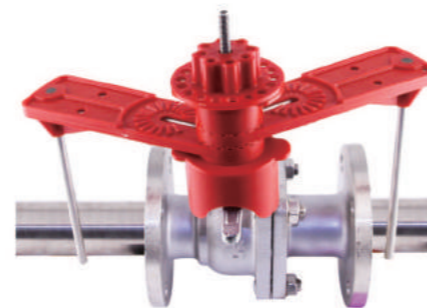

Model	Description
BD-8213	External dimensions: Length 375mm, Width 50mm, Height 275mm Suitable for handle width 19mm-46mm, suitable for handle maximum thickness 25mm, rotating arm length 170mm

## New Design Resin Valve Lockout

- Be made of impact resistant ABS, corrosion resistance and better insulation performance.
- One-piece design, can lock the small right angle rotating ball valve in closed position.
- With a knob can tighten directly to install, easy to use, without assistant tools.
- Use with professional safety padlock and tag together.
- Suitable for locking 1/4"~1" ball valve handle in closed condition.

Model	Description
BD-8215	External dimensions: Length 90mm, Width 77mm, Height 78mm



## New Design Metal Valve Lockout

- Heavy steel with painting.
- Easy to use, one-piece design, can lock the right angle turning ball valve in closed position.
- With a knob can tighten directly to install, easy to use, without assistant tools.
- Use with professional safety padlock and tag together.
- Suitable for locking 1 1/4"~2.5" ball valve handle in closed condition.

Model	Description
BD-8216	External dimensions: Length 200mm, Width 18mm, Height 130mm





## Butterfly Valve Lockout

- Be made of high strength polypropylene, excellent anti-fracture, wear resistance and insulation performance.
- Can adjust the position of the padlock arbitrarily, convenient and quick.
- Suitable for butterfly valve size: 0.25" - 2.5".
- Use with professional safety padlock and tag together.



Model	Description
BD-8221	External dimensions: Length 300mm, Width 106mm, Height 67mm

Step 1: Orthogonal

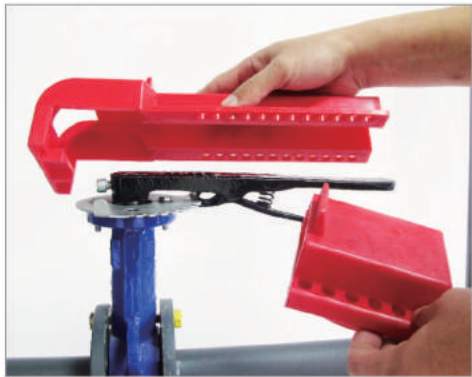

Step 2: Merge

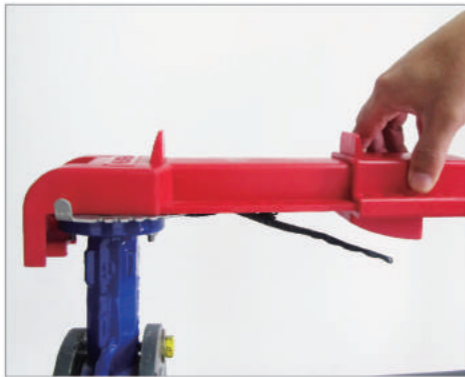

Step 3: Lock

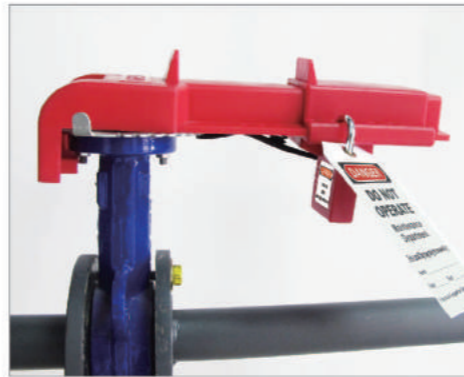

## Universal Butterfly Valve Lockout

- Be made of reinforced nylon PA6 and stainless steel, with better impact resistance and excellent chemical resistance.
- Advanced trapezoidal upper teeth improves the bite strength of valve handle.
- The stainless steel T-shape wedge fixes the butterfly valve jaw firmly.
- Use with professional safety padlock and tag together.

Model	Description
BD-8222	Suitable for handle width 19mm-46mm, suitable for handle maximum thickness 25mm

Step 1



Step 2



Step 3

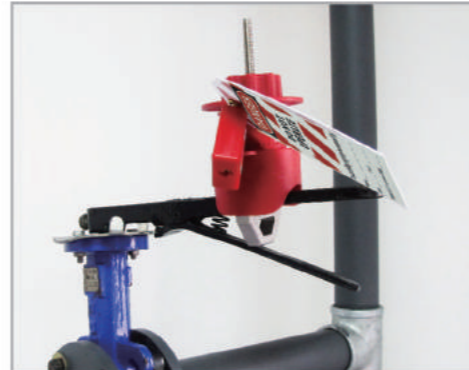

## Gate Valve Lockout

- It is high strength ABS injection molding, with better high temperature resistance, corrosion resistance, impact resistance and insulation performance.
- Working temperature: -20℃-80℃;
- Unique design of central bulge, after removing, can be used for lifting rod gate valve.
- According to the handle diameter, there are 5 specifications lockout to choose.
- Stick with a warning label and indicate the application scope.
- Half moon flat box design, can completely lock the valve handle to prevent misoperation.
- Use with professional safety padlock and tag together.



Model	Description
BD-8231	Suitable for the handle diameter: 25mm-63mm, back hole diameter: 19mm, disassembled circular hole diameter: 19mm
BD-8232	Suitable for the handle diameter: 63mm-127mm, back hole diameter: 32mm, disassembled circular hole diameter: 32mm
BD-8233	Suitable for the handle diameter: 127mm-165mm, back hole diameter: 53mm, disassembled circular hole diameter: 53mm
BD-8234	Suitable for the handle diameter: 165mm-254mm, back hole diameter: 70mm, disassembled circular hole diameter: 70mm
BD-8235	Suitable for the handle diameter: 254mm-330mm, back hole diameter: 70mm, disassembled circular hole diameter: 70mm

## Universal Gate Valve Lockout

- Be made of reinforced nylon PA6 and stainless steel, with better impact resistance and excellent chemical resistance.
- Suitable for the maximum thickness of the handle 25mm, applicable temperature -20℃-160℃.
- Advanced trapezoidal upper teeth and opening design lower teeth are easy to hitch the valve handle and improve the bite strength of valve handle.
- Use with professional safety padlock and tag together.



Model	Description
BD-8236	1.5m, 2.5m, 3.5m cable are available to choose



### Universal Valve Lockout



BD-8237

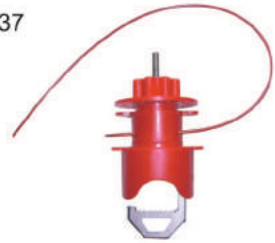

BD-8238

- Be made of reinforced nylon PA6 and stainless steel, with better impact resistance and excellent chemical resistance.
- Suitable for handle width 46mm, maximum thickness 22mm, applicable temperature -20 °C -160 °C.
- BD-8237 has adjustable arm, can adjust the length of the arm according to customers' requests.
- Use with professional safety padlock and tag together.

Model	Description
BD-8237	Can lock most of the ball valve, butterfly valve, gate valve
BD-8238	Can lock most of the butterfly valve, gate valve

### Pneumatic Lockout

- Be made of stainless steel, better antirust and corrosion resistance performance.
- Can lock air interface diameter 19mm, 15.5mm, 13.5mm, 12mm, 10.5mm, 9.5mm, 8mm, 6.5mm.
- Can lock air interface to prevent the air from being reconnected.
- External dimensions: Length 206mm, Width 33mm, Thickness 2.6mm.

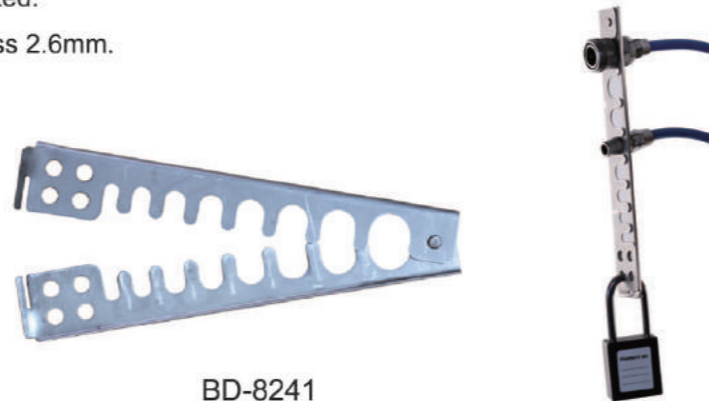
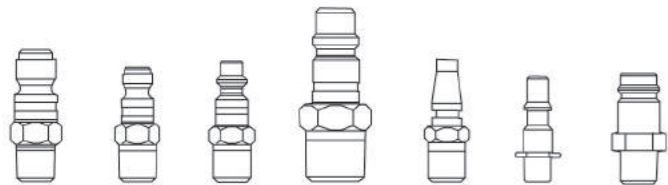

BD-8241

### Pressurized Gas Cylinder Valve Lockout



BD-8251

- Be made of high strength industrial ABS resin, with better impact resistance, chemical pollution resistance.
- Lock the gas cylinder high pressure valve, prevent to open, suitable for valve with limiter.
- Applicable to all gas cylinder high pressure valves, valve diameter range can up to 76mm.
- External dimensions: 152mm X 97mm

### Hasp Lockout

- Install the hasp lockout on the energy cut off switch so that the equipment cannot be operated during maintenance. multiple people can be locked at the same time.
- The equipment cannot be turned on unless the last person opens his/her padlock.



BD-8311  
1"Hasp Lock with 6 Holes



BD-8312  
1.5"Hasp Lock with 6 Holes



BD-8313  
Insulation Hasp Lock with 6 Holes



BD-8314  
Hasp Lock with 8 Holes

Model	Keyhole Quantity	Material	Jaw Size
BD-8311	6	Steel jaw, polypropylene injection handle	1"
BD-8312	6	Steel jaw, polypropylene injection handle	1.5"
BD-8313	6	ABS resin lock body and PA6 lock shackle, insulation, anti-chemical, anti-magnetic and non-conductive	78mm X 18mm
BD-8314	8	Zinc alloy, polypropylene injection handle	1.5"

### New Aluminum Hasp Lockout

**NEW!**

- Install the hasp lockout on the energy cut off switch so that the equipment cannot be operated during maintenance.
- The equipment cannot be turned on unless the last person opens his/her padlock.
- Can accommodate 6 people to lock, multiple people can be locked at the same time.



BD-8317  
1"Aluminum Hasp Lock with 6 Holes



BD-8318  
1.5"Aluminum Hasp Lock with 6 Holes

Model	Description	Jaw Size
BD-8317	Spark-proof aluminum jaw, polypropylene injection handle	1"
BD-8318	Spark-proof aluminum jaw, polypropylene injection handle	1.5"



### Heavy Steel Hasp Lockout with 4 Holes

- Be made of heavy steel.
- Can accommodate 4 padlocks.
- Install the hasp lockout on the energy cut off switch so that the equipment cannot be operated during maintenance. multiple people can be locked at the same time.
- The equipment cannot be turned on unless the last person opens his/her padlock.

Model	Description
BD-8315	External dimensions: Length 103mm, Width 45mm, Thickness 69mm

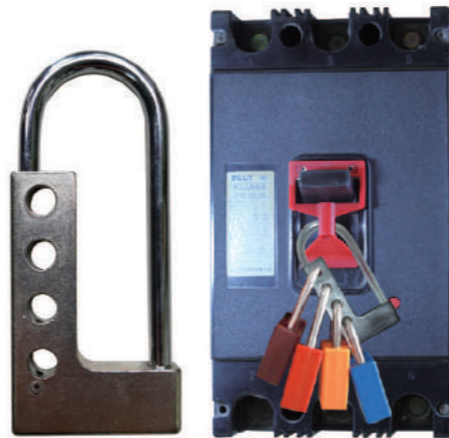

### New Design Hasp Lockout with 3 Holes.

- Be made of ABS resin, carbon steel with chrome plated shackle.
- 4mm steel thin shackle can meet small lock hole.
- Can accommodate 3 padlocks.

Model	Description
BD-8316	External dimensions: Length 103mm, Width 45mm, Thickness 69mm

### Aluminum Hasp Lock

- Be made of spark-proof aluminum, can accommodate 6 padlocks.
- External dimensions: Length 188mm, Width 76mm, Thickness 36mm
- Install the hasp lockout on the energy cut off switch so that the equipment cannot be operated during maintenance, multiple people can be locked at the same time
- The equipment cannot be turned on unless the last person opens his/her padlock.
- Lock body has warning labels, can write user's information.



BD-8321



BD-8322



BD-8323



BD-8324



BD-8325

### Aluminum Lockout Hasp

- Made from super aluminum alloy.
- The traditional hasp and tag integration become one.
- The combination of label and hasp improve the applicability of the product, and the temperature-resistance design of tag can be applied to different environment.
- Write-on labels surface accepts pencil, pen or marker, repeated uses allowed.
- All colors are available.



BD-8331



BD-8332



BD-8333

**NEW!**

### Nylon Lockout Hasp

- Made from alloy engineering plastics with American DuPont nylon shackle.
- Apply to where place electric power isolation and lock, high requirement of corrosive or explosion-proof places.
- Advantages: small and exquisite, can be applied to 3-6mm lock hole. Write available on the front and back.
- Allow to 4 padlocks.

Model	Description
BD-8341	Lock shackle diameter 3mm



**NEW!**

### Nylon Lockout Hasp

- Made from alloy engineering plastics with American DuPont nylon shackle.
- Apply to where place electric power isolation and lock, high requirement of corrosive or explosion-proof places.
- Advantages: small and exquisite, can be applied to 6mm lock hole. Write available on the front and back.
- Allow to 4 padlocks.



**NEW!**

Model	Description
BD-8342	Lock shackle diameter 6mm



### Aluminum Lockout Hasp

- Made from super aluminum alloy.
- The traditional hasp and tag integration become one.
- The combination of label and hasp improve the applicability of the product, and the temperature-resistance design of tag can be applied to different environment.
- Write-on labels surface accepts pencil, pen or marker, repeated uses allowed.
- All colors are available.



Model	Description
BD-8351	Allow to 6 padlocks



### Butterfly Lockout Hasp

- Made from hardened steel, galvanized rustproof surface.
- Hard to pry, sturdy and durable.

Model	Description
BD-8352	Allow to 7 padlocks

### Cable Lockout

- Can lock gate valves of all sizes and can lock electrical cabinet, easy to carry and widely used.
- Be made of ABS and stainless steel cable.
- Can accommodate 5 padlocks.
- Use with professional safety padlock and tag together.



BD-8411



BD-8421



Model	Description	External Dimensions
BD-8411	Stainless steel cable, 3mm diameter, 1.8m length. The length can be customized as requests	Length 128mm, Width 85mm, Thickness 20mm
BD-8421	Stainless steel cable with insulation cover, 3mm diameter, 1.8m length. The length can be customized as requests	Length 128mm, Width 85mm, Thickness 20mm

### Universal Cable Lockout

- Can lock gate valves of all sizes and can lock electrical cabinet, easy to carry and widely used.
- Be made of ABS and stainless steel cable.
- Can accommodate 5 padlocks.
- Use with professional safety padlock and tag together.



BD-8412



BD-8422



Model	Description
BD-8412	Stainless steel cable with PVC cover, 6mm diameter, 2m length. The length can be customized as requests
BD-8422	Stainless steel cable with insulation cover, 6mm diameter, 2m length. The length can be customized as requests

### Grip-cinching Cable Lockout

- Made from impact resistant engineering plastic nylon PA
- Used 1.6 meter stainless steel cable, the outer layer of cable is made from anti-UV PVC (diameter 4mm).
- Self-locking function, the cable lock is self-locking under the condition of not being operated, ensuring that the cable is not arbitrarily stretched, and the locking function is strong.
- Can write the label (in Chinese or in English) to identify the operator. Locked with 5 padlocks, lock shackle diameter is less than 7mm.



Model	Description
BD-8413	Include cable, the lock is open when the handle is in the bounce position.



### Universal Fish-shaped Insulation Cable Lockout

- Can lock gate valves of all sizes and can lock electrical cabinet, easy to carry and widely used.
- Be made of ABS and stainless steel cable, with insulation cover
- Can accommodate 6 padlocks.
- Use with professional safety padlock and tag together.

Model	Description	External Dimensions
BD-8431	Stainless steel cable with insulation cover, 5mm diameter, 2m length. The length can be customized as requests	Length 150mm, Width 57mm, Thickness 12mm



## Cable Padlock

- ABS lock body and 3mm diameter stainless steel cable.
- Can lock neighboring electrical appliances or other switch at the same time, saving the padlocks quantity and space, easy to manage.
- Use with professional safety padlock and tag together.

Model	Description
BD-8441	The cable length is 150mm. (The cable length can be customized as requests.)
BD-8442	The cable length is 240mm. (The cable length can be customized as requests.)



## Miniature Cable Lockout

**NEW!**



- Made from impact resistant engineering plastic nylon PA
- Used 0.5 meter stainless steel cable, the outer layer of cable is made from anti-UV PVC (diameter 1.5mm).
- Black part: push up to open the cable, push down to lock the cable  
Red part: print Lockout, warning
- After locking, the cable can only be tightened.
- Can customize label (in Chinese or in English)
- $\Phi 6$ mm hole and  $\Phi 8$ mm hole, suitable different types of shackles

Model	Description
BD-8443	Include cable

## Double Holes Cable Lockout

- Can lock all kinds of devices flexibly.
- More convenient than ordinary chain and easy to use.
- Red insulation stainless steel cable, colorful and durable.
- The length can be made as per requests.
- Use with professional safety padlock and tag together.

Model	Description
BD-8451	Cable diameter 5mm, length 2m



**NEW!**

## Retractable Cable Lockout

- ABS lock body and stainless steel cable.
- Unique and scientific retractable design, easy to use and stock.
- 3mm diameter, 2m length cable with insulation cover. Structure design confirms to lock firmly.
- Use with professional safety padlock and tag together.

Model	Description
BD-8461	External dimensions: Length 134mm, Width 105mm, Thickness 37mm

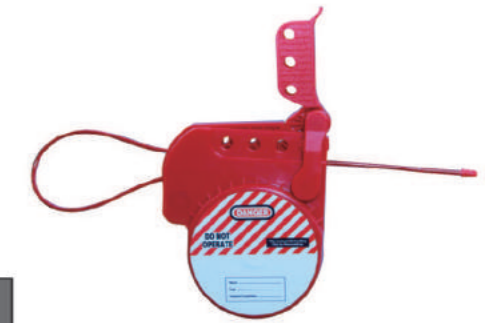

## Manway Lockout

- At first, press the top button then it when upspring, the lockout open; the cable can be extended according to you need.
- Lightly press the winding switch button, the cable can automatic retract.
- Not press the winding switch button, the cable will stop automatic retracting, at last press the top button and hang on safety padlock though the hole on the top button.



Model	Description
BD-8462	Include cable

## Manway Lockout

- The product is made of high-quality wear-resistant polyester cloth and uses high-quality technology to make the product more durable in harsh environments.
- Insert the hole in the triangle into the side hole ( $\geq 16$ mm), then straighten the three holes, and lock each hole with the corresponding side hole to achieve the lock.
- With professional design, different sizes of pipes can be locked (without changing their size)

Model	Description
BD-8471	External dimensions: 490mm x 490mm





## 4 Padlock Station

- Be made of ABS resin, corrosion resistant, impact resistant, easy for daily management.
- External dimensions: Length 301mm, Width 221mm.
- Four corner with holes, easy to install.
- Parts for reference: 4pcs BD-8521 red padlocks, 3pcs BD-8311 hasp lockout, 25pcs BD-8611 warning signs.

Model	Description
BD-8713	4 Padlock Station

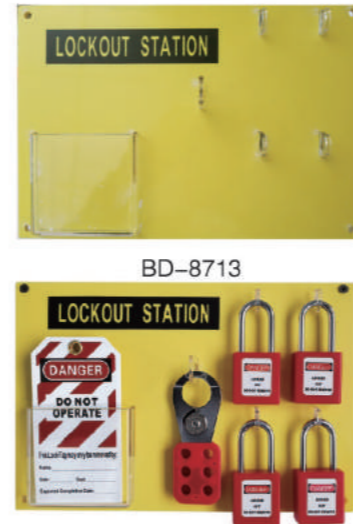

Parts for Reference



BD-8714



Parts for Reference

## 4 Padlock Station with Cover

- Be made of ABS resin, corrosion resistant, impact resistant.
- With transparent polycarbonate cover, can lock, easy for daily management.
- External dimensions: Length 307mm, Width 228mm, Thickness 65mm.
- Four corner with holes, easy to install.
- Parts for reference: 4pcs BD-8521 red padlocks, 3pcs BD-8311 hasp lockout, 25pcs BD-8611 warning signs.

Model	Description
BD-8714	4 Padlock Station with Cover

## 10 Padlock Station

- Be made of ABS resin, corrosion resistant, impact resistant, easy for daily management.
- External dimensions: Length 480mm, Width 300mm.
- Four corner with holes, easy to install.
- Parts for reference: 10pcs BD-8521 red padlocks, 3pcs BD-8311 hasp lockout, 25pcs BD-8611 warning signs.

Model	Description
BD-8723	10 Padlock Station



BD-8723 Parts for Reference

## 10 Padlock Station with Cover

- Be made of ABS resin, corrosion resistant, impact resistant.
- With transparent polycarbonate cover, can lock, easy for daily management.
- External dimensions: Length 487mm, Width 308mm, Thickness 65mm.
- Four corner with holes, easy to install.
- Parts for reference: 10pcs BD-8521 red padlocks, 3pcs BD-8311 hasp lockout, 25pcs BD-8611 warning signs.

Model	Description
BD-8724	10 Padlock Station with Cover



BD-8724 Parts for Reference

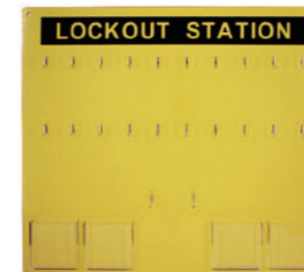

BD-8733



Parts for Reference

## 20 Padlock Station

- Be made of ABS resin, corrosion resistant, impact resistant, easy for daily management.
- External dimensions: Length 551mm, Width 479mm.
- Four corner with holes, easy to install.
- Parts for reference: 20pcs BD-8521 red padlocks, 3pcs BD-8311 hasp lockout, 3pcs BD-8312 hasp lockout, 50pcs BD-8611 warning signs.

Model	Description
BD-8733	20 Padlock Station

## 20 Padlock Station with Cover

- Be made of ABS resin, corrosion resistant, impact resistant.
- With transparent polycarbonate cover, can lock, easy for daily management.
- External dimensions: Length 558mm, Width 490mm, Thickness 65mm.
- Four corner with holes, easy to install.
- Parts for reference: 20pcs BD-8521 red padlocks, 3pcs BD-8311 hasp lockout, 3pcs BD-8312 hasp lockout, 50pcs BD-8611 warning signs.

Model	Description
BD-8734	20 Padlock Station with Cover



BD-8734



Parts for Reference



## Combination Padlock Station

- Be made of ABS resin, corrosion resistant, impact resistant.
- With transparent polycarbonate cover, can lock, easy for daily management.
- External dimensions: Length 500mm, Width 467mm, Thickness 104mm.
- Four corner with holes, easy to install.
- Parts for reference: 20pcs BD-8521 red padlocks, 3pcs BD-8311 hasp lockout, 3pcs BD-8312 hasp lockout, 1pc BD-8231 gate valve lockout, 1pc BD-8232 gate valve lockout, 1pc BD-8233 gate valve lockout, 25pcs BD-8611 warning signs.

Model	Description
BD-8752	Combination Padlock Station



BD-8752



Parts for Reference



BD-8761



BD-8762



BD-8763



BD-8764

## Safety Padlock Rack

- Be made of carbon steel with red spraying, safe and eye-catching.
- Used for hanging safety padlock(without padlock).
- Four specifications to choose.

Model	Description
BD-8761	Length 140mm, Width 40mm, Height 80mm, can hang 5pcs padlocks.
BD-8762	Length 270mm, Width 40mm, Height 80mm, can hang 10pcs padlocks.
BD-8763	Length 400mm, Width 40mm, Height 80mm, can hang 15pcs padlocks.
BD-8764	Length 530mm, Width 40mm, Height 80mm, can hang 20pcs padlocks.

## Lockout Kit

- Warning red, safe and eye-catching.
- External dimensions: Length 210mm, Width 145mm, Thickness 60mm.
- Small zipper bag, easy to carry, or wear the adjustable belt on waist.

Model	Description
BD-8771	Lockout Kit

### Parts for reference

1pc BD-8771 lockout kit, 1pcs BD-8611 lockout tags, 1pc BD-8121 circuit breaker lockout(small), 1pc BD-8111 miniature circuit breaker lockout, 1pc BD-8231 gate valve lockout, 1pc BD-8311 hasp lock(1"), 1pc BD-8312 hasp lock(1.5"), 1pc BD-8521 red padlock, 1pc BD-8511 red padlock, 10pcs bindings.



Lock-Out Kit

Parts for reference



## Lockout Kit

- The color is yellow and black.
- External dimensions: Length 300mm, Width 220mm, Thickness 240mm.
- Large capacity, can pack many safety lockout, portable or messenger, easy to carry.
- Include many lockout parts, meet most of the application. Can be used for many people, there are keyed to differ padlocks, which can avoid the key confusion effectively.



Parts for reference



Model	Description
BD-8772	Lockout Kit

### Parts for reference

1pc BD-8772 lockout kit, 10pcs BD-8611 lockout tags, 2pcs BD-8121 circuit breaker lockout(small), 2pcs BD-8111 miniature circuit breaker lockout, 1pc BD-8211 ball valve lockout, 1pc BD-8411 cable lockout, 1pc BD-8421 insulation cable lockout, 1pc BD-8231 gate valve lockout, 1pc BD-8232 gate valve lockout, 1pc BD-8233 gate valve lockout, 2pcs BD-8311 hasp lock(1"), 1pc BD-8312 hasp lock(1.5"), 1pc BD-8313 insulation hasp lockout, 3pcs BD-8521 red padlock, 2pcs BD-8511 red padlock, 20pcs bindings.

## Portable Lockout Box

- Be made of high carbon steel, red, can customize yellow or brown according to the requests..
- External dimensions: Length 260mm, Width 103mm, Height 152mm.
- Each locking point on equipment needs one padlock to secure the safety. Collect these keys and put into the box and each authorized worker locks his padlock on the box.
- After work, workers remove their own padlock from the box, then the keys can be got in the box.



BD-8811



BD-8812



BD-8813



Model	Description
BD-8811	Only one lock hole, suitable for single management
BD-8812	13 lock holes easy for multiple persons co-management. Only the last worker removes his/her padlock, can get the keys in the box.
BD-8813	13 lock holes, One side is transparent and visual management, which is convenient for many people to manage together.



## Combination Lockout Box

- Full plastic design, simplicity but not simple.
- Rubber handle with one-piece parts box.
- BD - 8773A dimensions: Length 360 mm, Width 180 mm, Height 180 mm, net weight is 1.0 KG.
- BD - 8774A dimensions: Length 470 mm, Width 240 mm, Height 200 mm, net weight is 1.6 KG.



BD-8773A



BD-8774A

NEW!

## Combination Lockout Box



BD-8773B



BD-8774B

- Thicken new box, be made of high quality PP plastic.
- Removable independent parts box.
- Thicken and widen stainless steel buckle, steel hinge.
- BD - 8773B dimensions: Length 360 mm, Width 180 mm, Height 180 mm, net weight is 1.25 KG.
- BD - 8774B dimensions: Length 470 mm, Width 240 mm, Height 200 mm, net weight is 2.0 KG.

## Combination Draw-bar Lockout Box

- Combination draw-bar lockout box, load-bearing ability, convenient and more practical, multi-storey design, reasonable structure, suitable for different industries.
- High quality and light wheels, flexible rotation, three layers combination, solid metal connector, multi-functional.
- External dimensions: Length 520mm, Width 320mm, Height 720mm.
- The first layer internal dimensions: Length 440mm, Width 220mm, Height 200mm.
- The second layer internal dimensions: Length 390mm, Width 210mm, Height 60mm.
- The third layer internal dimensions: Length 410mm, Width 200mm, Height 280mm.
- Be made of carbon steel spraying and ABS, net weight is 15.8 KG



BD-8775

NEW!

## Metal Lockout Station

- Be made of the steel with high temperature spraying.
- Warning yellow, beautiful and eye-catching.
- There are two pieces removable partition, can set interlayer space according to the requests flexibly.
- Can be hung on the wall or carried with you.
- There has padlock hole on the station cover, easy to manage and lock.
- BD - 8737 external dimensions: Length 360mm, Width 450mm, Height 155mm.



BD-8737

NEW!



BD-8738

NEW!

## Metal Lockout Station

- Be made of the steel with high temperature spraying.
- Warning yellow, beautiful and eye-catching.
- There has 30 hooks for padlock, each hook can hang two padlocks and hasp lockout.
- Can be hung on the wall or carried with you.
- There has padlock hole on the station cover, easy to manage and lock.
- BD - 8738 external dimensions: Length 560mm, Width 460mm, Height 70mm.

## Metal Lockout Station

- Be made of the steel with high temperature spraying.
- Warning red, beautiful and eye-catching.
- There has 22 hooks for padlock, each hook can hang two padlocks and hasp lockout, can put 40 warning signs.
- Can be hung on the wall or carried with you.
- There has padlock hole on the station cover, easy to manage and lock.
- BD-8739 external dimensions: Length 560mm, Width 430mm, Height 90mm.



BD-8739

NEW!

## Glove Clip

- Be made of POM, light and durable.
- Easy for daily use.
- External dimensions: Length 127mm, Width 32mm.
- Maximum load bearing: 5KG.



BD-001

NEW!

## Tape Dispenser

- Use tape dispenser to stick line on the ground can improve the work efficiency, reduce workers intensity, ensure quality of the line, save time and labor.
- Metal frame structure, light and durable.
- The maximum stick width is 100 mm.

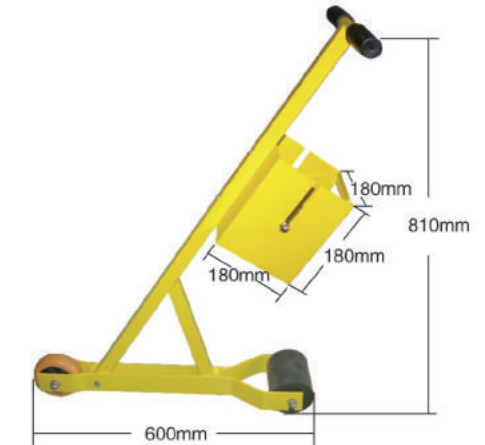

BD-8911



## Wall Mounted Eye Wash

**Technical Data:**

**Valve:** Eye wash valve is made of 1/2" 304 stainless steel ball valve

**Supply:** 1/2" FNPT

**Waste:** 1 1/4" MNPT

**Eye Wash Flow** ≥ 11.4L/Min

**Hydraulic Pressure:** 0.2MPa-0.6MPa

**Original Water:** Drinking water or filtered water

**Using Environment:** Places where has hazardous substance splashing, such as chemicals, hazardous liquids, solid, gas and other contaminated environment where may be burning.

**Special Note:** If the acid concentration is too high, recommend to use 316 stainless steel.

When using ambient temperature below 0°C, use antifreeze eye wash.

Standard: ANSI Z358.1-2014

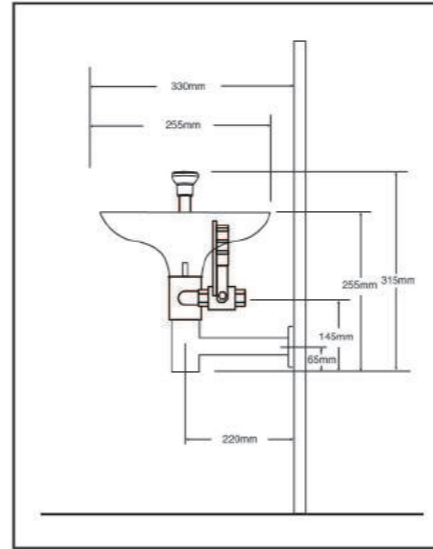

## Stand Eye Wash

**Technical Data:**

**Valve:** Eye wash valve is made of 1/2" 304 stainless steel ball valve

**Supply:** 1/2" FNPT

**Waste:** 1 1/4" FNPT

**Eye Wash Flow** ≥ 11.4L/Min

**Hydraulic Pressure:** 0.2MPa-0.6MPa

**Original Water:** Drinking water or filtered water

**Using Environment:** Places where has hazardous substance splashing, such as chemicals, hazardous liquids, solid, gas and other contaminated environment where may be burning.

**Special Note:** If the acid concentration is too high, recommend to use 316 stainless steel.

When using ambient temperature below 0°C, use antifreeze eye wash.

Can install anti-scalding device to avoid the media temperature is too high in the pipe after the sun exposure and cause user scalding. The standard anti-scalding temperature is 35°C.

Standard: ANSI Z358.1-2014

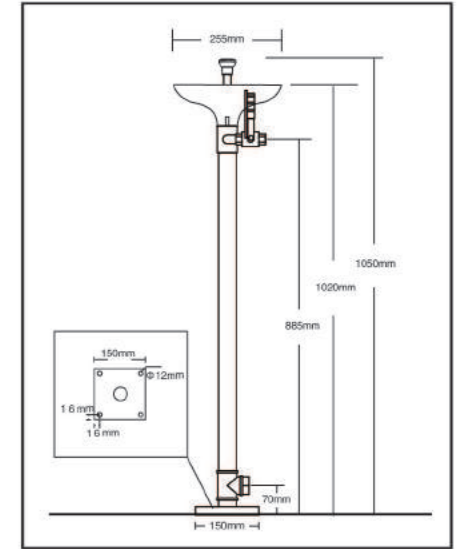

**BD-508A**

304 stainless steel



**BD-508C**

304 stainless steel  
ABS single nozzle

**NEW!**



**BD-508B**

304 stainless steel  
ABS bowl



**BD-508D**

304 stainless steel  
ABS bowl and single nozzle

**NEW!**



**BD-540E**

304 stainless steel  
ABS single nozzle

**NEW!**



**BD-540F**

304 stainless steel  
ABS bowl and single nozzle

**NEW!**



**BD-540A**

304 stainless steel  
ABS bowl



**BD-540C**

304 stainless steel



**BD-540N**

304 stainless steel  
ABS foot pedal



## Combination Eye Wash & Shower

### Technical Data:

**Head:** 10" stainless steel or ABS

**Eye Wash Nozzle:** ABS spraying with 10" waste water recycle bowl

**Shower Valve:** 1" 304 stainless steel ball valve

**Eye Wash Valve:** 1/2" 304 stainless steel ball valve

**Supply:** 1 1/4" FNPT

**Waste:** 1 1/4" FNPT

Eye Wash Flow  $\geq 11.4$  L/Min, shower flow  $\geq 75.7$  L/Min

**Hydraulic Pressure:** 0.2MPA-0.6MPA

**Original Water:** Drinking water or filtered water

**Using Environment:** Places where has hazardous substance splashing, such as chemicals, hazardous liquids, solid, gas and so on.

**Special Note:** If the acid concentration is too high, recommend to use 316 stainless steel.

When using ambient temperature below 0°C, use antifreeze eye wash.

The eye wash & shower is made of high quality 304 stainless steel.

Can install anti-scalding device to avoid the media temperature is too high in the pipe after the sun exposure and cause user scalding. The standard anti-scalding temperature is 35°C.

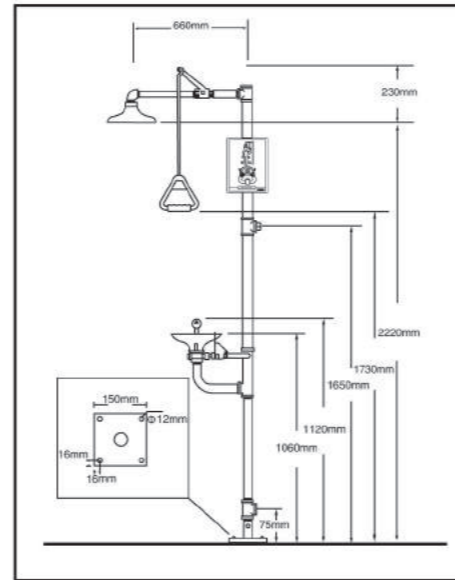

## BD-530

### Higher Stainless Steel Combination Eye Wash & Shower

#### Technical Data:

**Head:** 10" stainless steel

**Eye Wash Nozzle:** Green ABS spraying with 10" waste water recycle bowl

**Shower Valve:** 1" 304 stainless steel ball valve

**Eye Wash Valve:** 1/2" 304 stainless steel ball valve

**Supply:** 1" FNPT

**Waste:** 1" FNPT

Eye Wash Flow  $\geq 11.4$  L/Min, shower flow  $\geq 75.7$  L/Min

**Hydraulic Pressure:** 0.2MPA-0.6MPA

**Original Water:** Drinking water or filtered water

**Using Environment:** Places where has hazardous substance splashing, such as chemicals, hazardous liquids, solid, gas and so on.

**Special Note:** If the acid concentration is too high, recommend to use 316 stainless steel.

When using ambient temperature below 0°C, use antifreeze eye wash.

The eye wash & shower is made of high quality 304 stainless steel, the inner wall is polished and it will not keep the water impurities, especially for the laboratory, medical and food industries.

Can install anti-scalding device to avoid the media temperature is too high in the pipe after the sun exposure and cause user scalding. The standard anti-scalding temperature is 35°C.

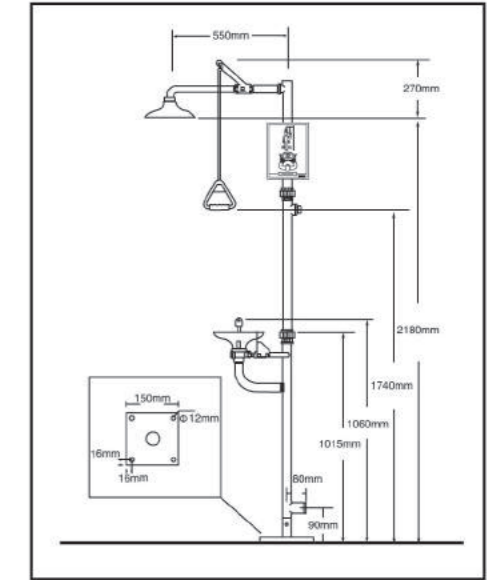

Standard: ANSI Z358.1-2014



### BD-550A

304 stainless steel  
ABS foot pedal

### BD-550B

304 stainless steel  
ABS foot pedal  
ABS single nozzle

### BD-550C

304 stainless steel  
ABS foot pedal  
ABS head and bowl

### BD-550D

304 stainless steel  
ABS foot pedal  
ABS head and bowl  
and single nozzle



### BD-560

304 stainless steel

### BD-560G

304 stainless steel  
ABS single nozzle

### BD-560H

304 stainless steel  
ABS head and bowl

### BD-560K

304 stainless steel  
ABS bowl cover

### BD-560N

304 stainless steel  
ABS head and bowl  
and single nozzle

## BD-560D

### Anti-freeze and Automatic Emptying Stainless Steel Combination Eye Wash & Shower

#### Technical Data:

**Material:** 304 stainless steel

**Head:** 10" stainless steel

**Eye Wash Nozzle:** Green ABS spraying with 10" waste water recycle bowl

**Supply Valve:** 1" 304 stainless steel T-type ball valve

**Shower Valve:** 1" 304 stainless steel ball valve

**Eye Wash Valve:** 1/2" 304 stainless steel ball valve

**Supply:** 1" MNPT

**Waste:** 1" MNPT

Eye Wash Flow  $\geq 11.4$  L/Min, shower flow  $\geq 75.7$  L/Min

**Hydraulic Pressure:** 0.2MPA-0.6MPA

**Original Water:** Drinking water or filtered water

**Using Environment:** Places where has hazardous substance splashing, such as chemicals, hazardous liquids, solid, gas and so on.

**Special Note:** If the acid concentration is too high, recommend to use 316 stainless steel.

After using, the water supply is stopped after the foot leaves the pedal, at the same time, the water in the pipe is drained automatically, and play the anti freeze function in winter outdoor.

Can install anti-scalding device to avoid the media temperature is too high in the pipe after the sun exposure and cause user scalding. The standard anti-scalding temperature is 35°C.

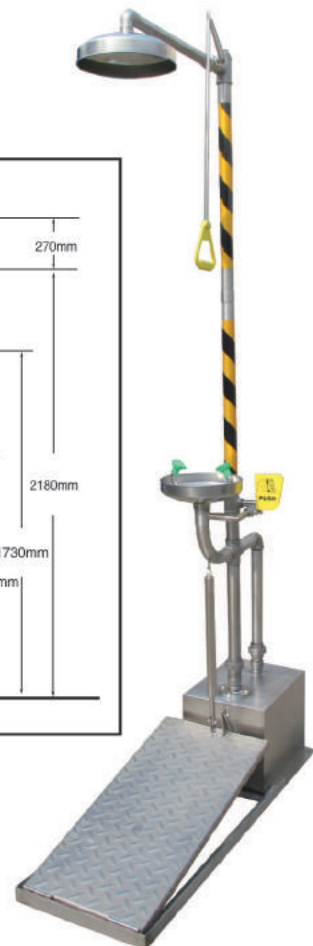
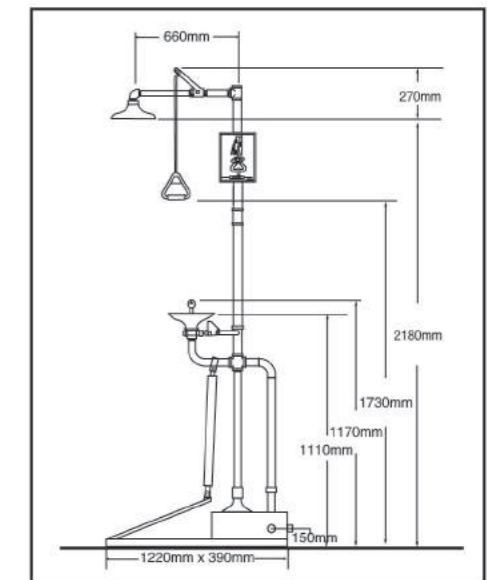

Standard: ANSI Z358.1-2014

Standard: ANSI Z358.1-2014



## Explosion Proof with Cable Heated Freeze Resistant Eye Wash & Shower

### Technical Data:

**Head:** ABS with warning yellow

**Eye Wash Nozzle:** ABS spraying with 10" ABS waste water recycle bowl, warning yellow

**Shower Valve:** 1" 304 stainless steel ball valve

**Eye Wash Valve:** 1/2" 304 stainless steel ball valve

**Waste:** 1 1/4" MNPT

Eye Wash Flow  $\geq 11.4$  L/Min, shower flow  $\geq 75.7$  L/Min

**Hydraulic Pressure:** 0.2MPA-0.6MPA

**Voltage:** 220V~250V

**Original Water:** Drinking water or filtered water

**Using Environment:** Places where has hazardous substance splashing, such as chemicals, hazardous liquids, solid, gas and so on.

**Special Note:** This eye wash is used in flammable environment or explosion proof area, according to the environment to customize the corresponding explosion proof grade, slightly different appearance in kind prevail.

The cable heated eye wash shower is antifreeze for outdoor, which provides emergency assistance and primary treatment. It composes main pipe, heat cable, inner and outer heat preservation layer, and the main pipe is made of 304 stainless steel.

Standard: ANSI Z358.1-2014

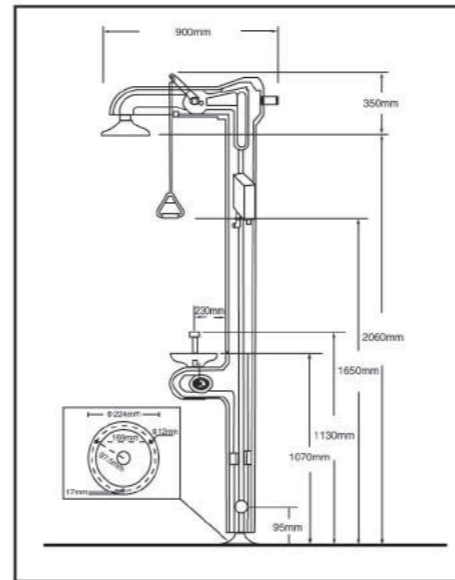

## BD-590

### Cable Heated Economical Eye Wash & Shower

#### Technical Data:

**Head:** 304 stainless steel

**Eye Wash Nozzle:** Green ABS spraying with 10" 304 stainless steel waste water recycle bowl

**Shower Valve:** 1" 304 stainless steel ball valve

**Eye Wash Valve:** 1/2" 304 stainless steel T-type ball valve

**Supply:** 1" MNPT

**Waste:** 1 1/4" MNPT

Eye Wash Flow  $\geq 11.4$  L/Min, shower flow  $\geq 75.7$  L/Min

**Hydraulic Pressure:** 0.2MPA-0.6MPA

**Voltage:** 220V~250V

**Power:** 200W

**Original Water:** Drinking water or filtered water

**Using Environment:** Places where has hazardous substance splashing, such as chemicals, hazardous liquids, solid, gas and so on.

**Special Note:** This eye wash is used in flammable environment or explosion proof area, according to the environment to customize the corresponding explosion proof grade, slightly different appearance in kind prevail.

The eye wash shower is antifreeze for outdoor, which can be used between  $-25^{\circ}\text{C}$ ~ $45^{\circ}\text{C}$ , shell is acid and alkali resistant PVC, the inner pipe is 304 stainless steel winded by high performance heated cable, the heat preservation layer is made of polyurethane, the color is white and green.

Standard: ANSI Z358.1-2014

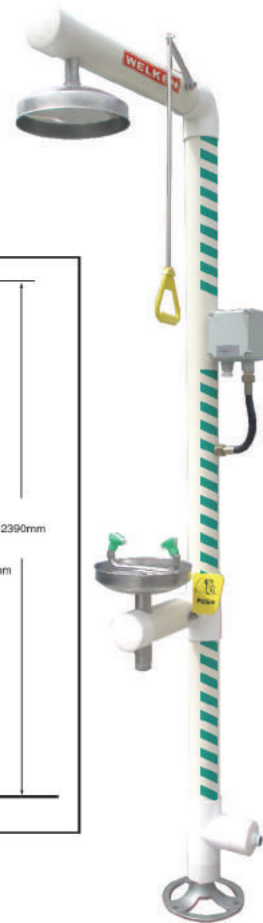
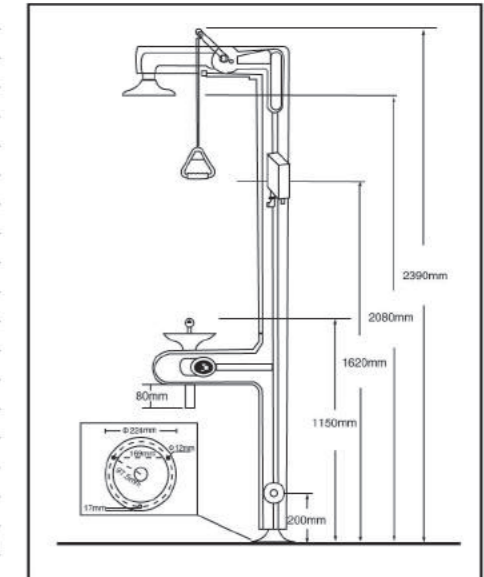

### BD-580

Using Temperature:  
 $-35^{\circ}\text{C}$ ~ $45^{\circ}\text{C}$   
Supply: 1" MNPT  
Power: 200W



### BD-580A

Using Temperature:  
 $-35^{\circ}\text{C}$ ~ $45^{\circ}\text{C}$   
Supply: 1" MNPT  
Power: 800W  
Remark:  
Stainless steel  
with electrical  
heating water  
tank, the volume  
is 350L.



### BD-580B

Using Temperature:  
 $-35^{\circ}\text{C}$ ~ $45^{\circ}\text{C}$   
Supply: 1" FNPT  
Power: 250W  
Remark:  
Explosion proof  
lighting, sound  
and light alarm,  
flow switch, and  
junction box.



### BD-580C

Using Temperature:  
 $-35^{\circ}\text{C}$ ~ $45^{\circ}\text{C}$   
Supply: 1" FNPT  
Power: 250W  
Remark:  
Explosion proof  
sound and light  
alarm, flow switch,  
temperature  
control box and  
junction box.

## BD-540D

### Cable Heated Stand Eye Wash

#### Technical Data:

**Valve:** Eye wash valve is made of 1/2" 304 stainless steel ball valve

**Supply:** 1/2" MNPT

**Waste:** 1 1/4" FNPT

Eye Wash Flow  $\geq 11.4$  L/Min

**Hydraulic Pressure:** 0.2MPA-0.6MPA

**Original Water:** Drinking water or filtered water

**Using Environment:** Places where has hazardous substance splashing, such as chemicals, hazardous liquids, solid, gas and so on. This eye wash is used in flammable environment or explosion proof area, according to the environment to customize the corresponding explosion proof grade, slightly different appearance in kind prevail.

The stand eye wash is antifreeze for outdoor, which can be used between  $-25^{\circ}\text{C}$ ~ $45^{\circ}\text{C}$ , shell is acid and alkali resistant PVC, the inner pipe is 304 stainless steel winded by high performance heated cable, the heat preservation layer is made of polyurethane, the color is white and green.

Standard: ANSI Z358.1-2014

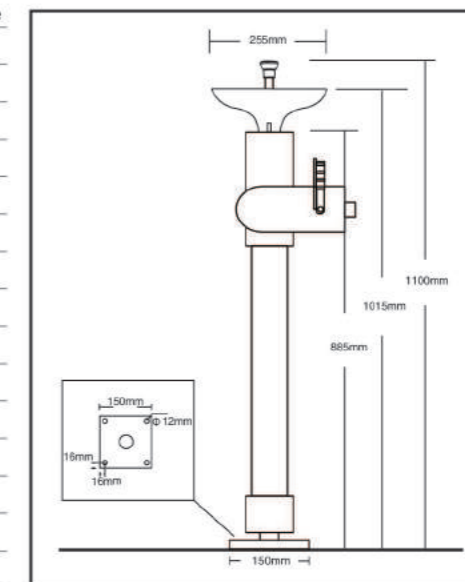



## ABS Eye Wash

### BD-510

#### Technical Data:

**Head:** 10" ABS, warning yellow

**Eye Wash Nozzle:** ABS spraying with 10" ABS waste water recycle bowl, warning yellow

**Shower Valve:** 1" 304 stainless steel ball valve

**Eye Wash Valve:** 1/2" corrosion resistant brass spool

**Supply:** 1" MNPT

**Waste:** 1 1/4" FNPT

Eye Wash Flow  $\geq 11.4$  L/Min, shower flow  $\geq 75.7$  L/Min

**Hydraulic Pressure:** 0.2MPA-0.4MPA

**Original Water:** Drinking water or filtered water

**Using Environment:** Places where has hazardous substance splashing, such as chemicals, hazardous liquids, solid, gas and other contaminated environment where may be burning.

**Special Note:** The best using ambient temperature is above 10°C.

The whole body is made of high quality ABS, better corrosion resistance, economical. Warning yellow, eye-catching.

Standard: ANSI Z358.1-2014



### BD-540B

#### Technical Data:

**Valve:** Eye wash valve is made of 1/2" corrosion resistant brass spool

**Supply:** 1/2" FNPT

**Waste:** 1 1/4" FNPT

Eye Wash Flow  $\geq 11.4$  L/Min

**Hydraulic Pressure:** 0.2MPA-0.4MPA

**Original Water:** Drinking water or filtered water

**Using Environment:** Places where has hazardous substance splashing, such as chemicals, hazardous liquids, solid, gas and other contaminated environment where may be burning.

**Special Note:** The best using ambient temperature is above 10°C.

The whole body is made of high quality ABS, better corrosion resistance, economical. Warning yellow, eye-catching.

Standard: ANSI Z358.1-2014

## Portable Eye Wash

#### Technical Data:

**Material:** 304 stainless steel

**Eye Wash Valve:** 1/2" 304 stainless steel ball valve

**Pressure:** The eye wash provides water by air pressure, common air pressure: 0.6MPA

**Original Water:** Drinking water, add water to the tank through the water supply at the top of the tank

**Water Storage:** 45L

**Using Temperature:** Ambient temperature range is 5°C-45°C

**Special Note:** If the temperature is below 5°C, please use heat preservation measures or buy electric heat preservation cover.

Do not use if the temperature is higher than 45°C, in order to avoid scalding, need to cool before use.

Portable eye wash is very easy to operate, can use more than ten minutes continuously, suitable for outdoor where has no fixed water supply. The portable eye wash is also equipped with a portable cart that can be placed anywhere.

Standard: ANSI Z358.1-2014

### BD-570

Dimensions:  
D 325mm X H 950mm



### BD-570A

Dimensions:  
D 325mm X H 2000mm  
Shower Valve:  
3/4" 304 stainless steel  
ball valve



## Portable Eye Wash

#### Technical Data:

**External Dimensions:** Water tank W 540mm X D 300mm X H 650mm

**Water Storage:** 60L

**Flushing Time:** >15 minutes

**Original Water:** Drinking water or saline, and pay attention to quality guarantee period

**Using Environment:** Places where has no water supply.

This portable eye wash is made of polyethylene, safe green, suitable for using in the place without water supply, please use drinking or filtered water or saline. And pay attention to regular cleaning, after cleaning refilled with drinking water or saline.

Standard: ANSI Z358.1-2014



### BD-600A

### BD-600B

BD-600B handcart dimensions  
H 1000mm X W 400mm X T 580mm,  
with 2 omni-directional wheels



## Rapid Response Portable Decontamination Shower

#### Technical Data:

**External Dimensions:** W1280mm X D1300mm X H2250mm

**Material:** High quality stainless steel

**Supply:** 1/4" FNPT

**Pressure:** 0.8MPA~1.5MPA

**Flow Rate:** 180L/Min

Specifically for the firefighters and accidents need to emergency cleaning, supply water by pressurized pump, the water pressure can reach 1.56MPA high pressure, can quickly clear the hazardous on the protective clothing or chemical protective clothing, easy to assemble and carry. Customers need to use their own pump, recommend pump power: 1.1KW.

Standard: ANSI Z358.1-2014

### BD-601



## Aluminum Miller Tripod

#### Technical Data:

**Rated Load:**  $\leq 3$ KN

**Maximum Load:** 300KGS

**Length:** Maximum closing length 2.2m, minimum closing length 1.69m

**Cable Length:** 30m

**Handle Force:** 0.2KN

**Working Height:** Maximum working height 1.95m, minimum working height 1.15m

The multi-function tripod is made of high strength light weight alloy, which is easy to use and durable for life saving and narrow space operation. Tripod feet can be extended according to the requests, with fixed connection ring which can install falling self-locking device and has an annular protection chain. Winch is positive and negative self locking structure with 30m stainless steel cable.

Comply with the EU General Safety Product Directive:2001/95/EC

### BD-610

